

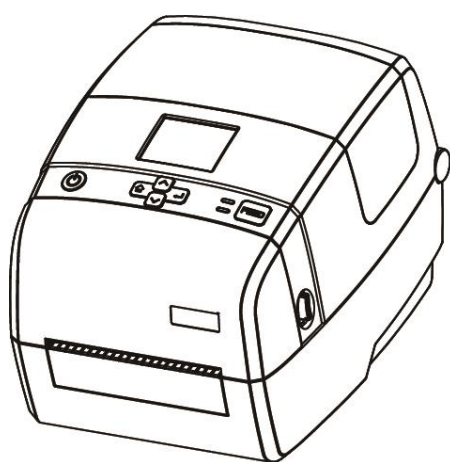

*Let Things Better,  
Faster and Vital*

# iD4 Series User Manual



**iD4P**

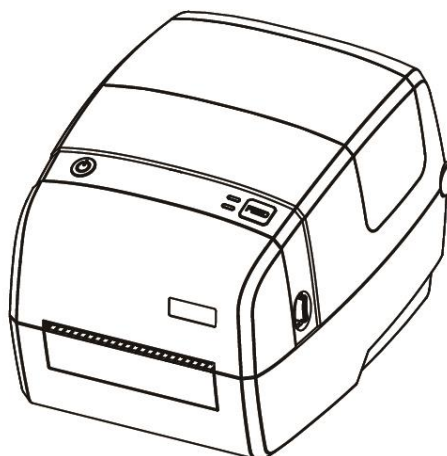

**iD4S**

**Xiamen Hanin Electronic Technology Co.,Ltd.**

ADD:5F, 8#, Aide Airport Industrial Park, Huli District, Xiamen, China

WEB:[www.idprt.com](http://www.idprt.com)

Rev.1.4

---

# Contents

Manual Information .....	1
Important Safety Instructions.....	2
Chapter 1 Introduction .....	5
1.1 Packing List .....	5
1.2 Appearance and Components .....	6
1.3 Dimension.....	8
Chapter 2 Specifications .....	9
Chapter 3 Installation & Usage .....	11
3.1 Media Loading .....	11
3.1.1 Loading the Roll .....	11
3.2 Power Connection .....	14
3.3 Peripherals Connection .....	15
3.3.1 Interface Cable Connection .....	15
3.3.2 Bluetooth Connection .....	15
3.4 Detection .....	16
3.4.1 Continuous Paper .....	16
3.4.2 Labels.....	18
3.4.3 Punched Hole Label .....	20
3.4.4 Blackmark Paper .....	21
3.5 Operation Panel.....	22
3.5.1 Panel Introduction .....	22
3.5.2 Display Operation .....	26
3.5.3 Indicator Instructions .....	29
3.6 Basic Function.....	30
3.6.1 Power On/ Power Off .....	30
3.6.2 FEED Button.....	30
3.6.3 Quick Calibration .....	30
3.6.4 Print Self-test Page .....	31
Chapter 4 Interface.....	32
4.1 USB Interface .....	32
4.2 Other Optional Interfaces.....	33
Chapter 5 Maintenance & Adjustment .....	34
5.1 Cleaning Media Sensor .....	34
5.2 Cleaning Thermal Print Head .....	34
5.3 Cleaning Roller and/or Paper Path .....	35
Chapter 6 Printer Utility Tool Instructions.....	36
6.1 Installation Preparation .....	36
6.2 Usage .....	36
Chapter 7 Seagull Windows Driver Instructions.....	53
7.1 Introduction.....	53
7.2 Installation Preparation .....	53

---

---

7.3 Installation .....	54
7.4 Usage .....	60
7.4.1 Printing Preferences .....	60
7.4.2 Printer Properties .....	74
Chapter 8 BarTender Ultralite Instructions .....	77
8.1 Introduction.....	77
8.2 Installation Preparation .....	77
8.3 Installation .....	78
8.4 Usage .....	82
8.4.1 Page Settings .....	82
8.4.2 label Edit.....	91
Appendix 1 Display Operation .....	97
Appendix 2 Download Path for UTILITY and Driver.....	102

---



## ■ Statement

This manual content may be altered without permission, and our company reserves the rights to make changes without notice in technology, spare parts, hardware and software of the products. If more information is needed about the products, please contact our company. Without any written permission from our company, any section of this manual is prohibited to be copied or transferred in any form.

## ■ Copyright

This manual is printed in 2019, the copyright belongs to Xiamen Hanin Electronic Technology Co., Ltd.

Printed in China

1.4 Version

## ■ Warnings



This must be complied with in order to avoid any damage to the human body and the equipment.



This is showing the important information and tips for the printer operation.



**Note: Due to continuous update of our product, the description of printer specification, accessories, design in this manual may be slightly different. Please keep in kind prevail.**

---

## **Manual Information**

This user manual contains basic information for product usage as well as for emergency measures that may be required.

The installation and usage of printer driver, utility tool and iDPRT BarTender Ultralite are also included in the manual.

# Important Safety Instructions

Before using the appliance, please carefully read the following safety regulations in order to prevent any hazard or material damage.

## 1. Safety warning



Warnings: The print head will become very hot during printing; avoid contact with the print head after printing has finished.



Warnings: Do not touch the printer head and connector in case static damage the printer head.

## 2. Instructions



Warnings: Violating following instructions can cause serious injury or death.

- 1) Do not plug several products in one multiperture outlet.
  - This can provoke over-heating and a fire.
  - If the plug is wet or dirty, dry or wipe it before usage.
  - If the plug does not fit perfectly with the outlet, do not plug in.
  - Be sure to use only standardized multiperture outlet.
- 2) You must use the supplied adapter.
  - It is dangerous to use other adapters.
- 3) Do not pull the cable to unplug.
  - This can damage the cable, which is the origin of a fire or a breakdown of the printer.
- 4) Do not plug in or unplug with your wet hands.
  - You can be electrocuted.
- 5) Do not bend the cable by force or leave it under any heavy object.
  - A damaged cable can cause a fire.



**Note: Violating following instructions may cause slight damage of the appliance.**

- 1) If you observe a strange smoke, odour or noise from the printer, unplug it before taking following measures.
    - Switch off the printer and unplug the set from the mains.
    - After the disappearance of the smoke, call your dealer to repair it.
  - 2) Install the printer on the stable surface.
    - If the printer falls down, it can be broken and you can hurt yourself.
  - 3) Use the approved accessories only and do not try to disassemble, repair or remodel it by yourself.
    - Call your dealer when you need these services.
    - Do not touch the blade of auto cutter.
  - 4) Do not let water or other foreign objects drop into the printer.
    - If this happened, switch off and unplug the printer before calling your dealer.
  - 5) Do not use the printer when it is out of order. This can cause a fire or an electrocution.
    - Switch off and unplug the printer before calling your dealer.
  - 6) Other considerations:
    - Place the printer on a solid and even base so that it cannot fall.
    - Leave enough space around printer for operation and maintenance.
    - Keep all liquids away from the printer.
    - Do not expose the printer to high temperatures, direct sunlight or dust.
    - Ensure the printer is connected to a socket with the correct mains voltage.
    - Switch off the printer POWER supply when it's not in use for a long time.
    - To ensure the printing quality and reliability, suggest use the same quality or recommend paper supplier.
    - Pls. switch off the POWER supply when connect/disconnect all the ports or it will cause damage to the printer control circuit.
    - Never carry out maintenance or repair work yourself. Always contact a qualified service Technician.
    - Keep this User Manual in a place which is easily accessible at all times.
-

### 3. Other Precautions

The copyright for this user manual and various other manuals is property of our company. Any copying or conversion into electronic form and saving of this material without the express written permission is strictly prohibited. Use of the information contained in this manual is not subject to any patent liability. This manual has been prepared with utmost care and attention to detail but may contain certain errors and/or omissions. Our company is not legally liable for any damages resulting from the use of the information in this manual. Our company and its affiliates are not legally liable (United States excluded) for any damages, loss, costs, and/or expenses that result from the breakdown, malfunction, and/or misuse of the product due to violation or neglect of the operation and maintenance information and instructions provided by our company, as well as from the unauthorized alteration, repair, and/or modification of the product by the user and/or third party. We are not legally liable for any damages and/or issues resulting from the use of options and/or parts that are not authentic or authorized products.

### 4. WEEE (Waste Electrical and Electric Equipment)



This mark shown on the product or its literature indicates that the corresponding item should not be discarded at the end of its working life with other household waste. To prevent possible harm to the environment or human health from uncontrolled waste disposal, please separate marked items from other types of waste and recycle them responsibly to promote the sustained reuse of material resources. Household users should contact either the retailer where they purchased this product, or their local government office for details of where and how they can conduct environmentally safe recycling of such items. Commercial users should contact their suppliers and check the terms and conditions of purchase contracts. This product should not be combined with other commercial waste for disposal.



**Caution: This is a Class A product. In a domestic environment this product may cause radio interference in which the user may be required to take adequate measures.**

# Chapter 1 Introduction

## 1.1 Packing List

1. Unpack the printer and keep the packing material in case you need to ship the printer in the future.
2. Any damages exist, please contact the local dealer.



Printer(eg: iD4P)

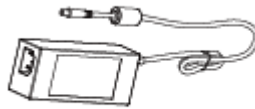

AC Adapter



Power Cord



USB Cable

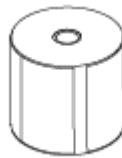

Label Roll



CD



Quick Start Guide



**Note:** The packing materials are actually based on the order.

## 1.2 Appearance and Components

### ■Front View

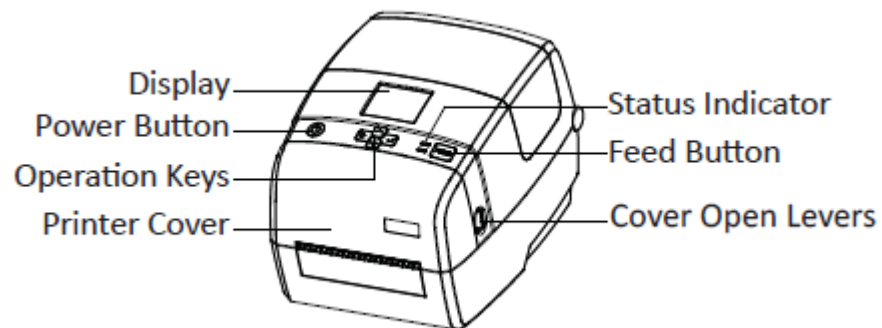

### ■Rear View

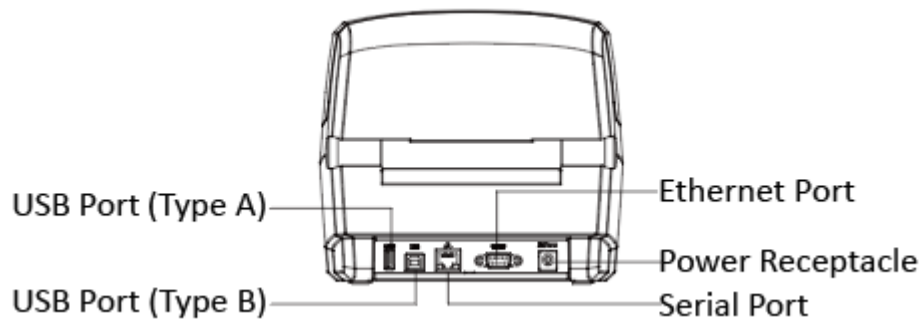

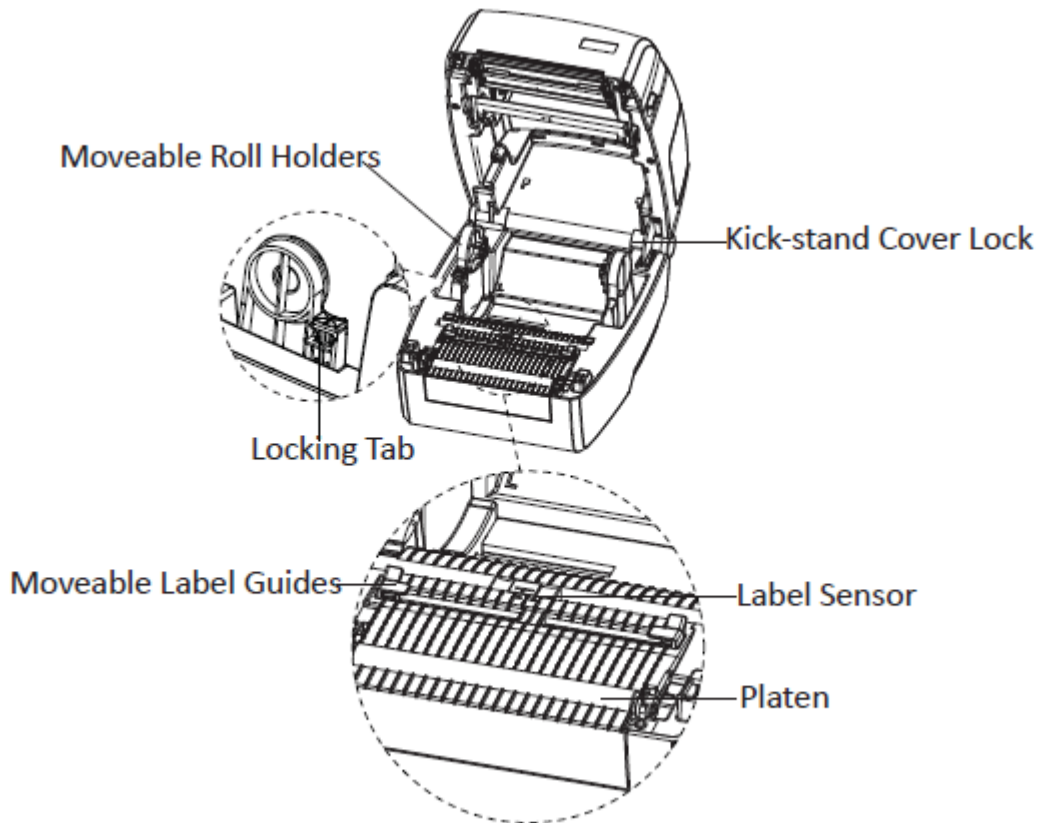
**■ Inside View**

**Note:** The views above are for your reference. Ports vary by your choice.

### 1.3 Dimension

Take printer iD4P as example.

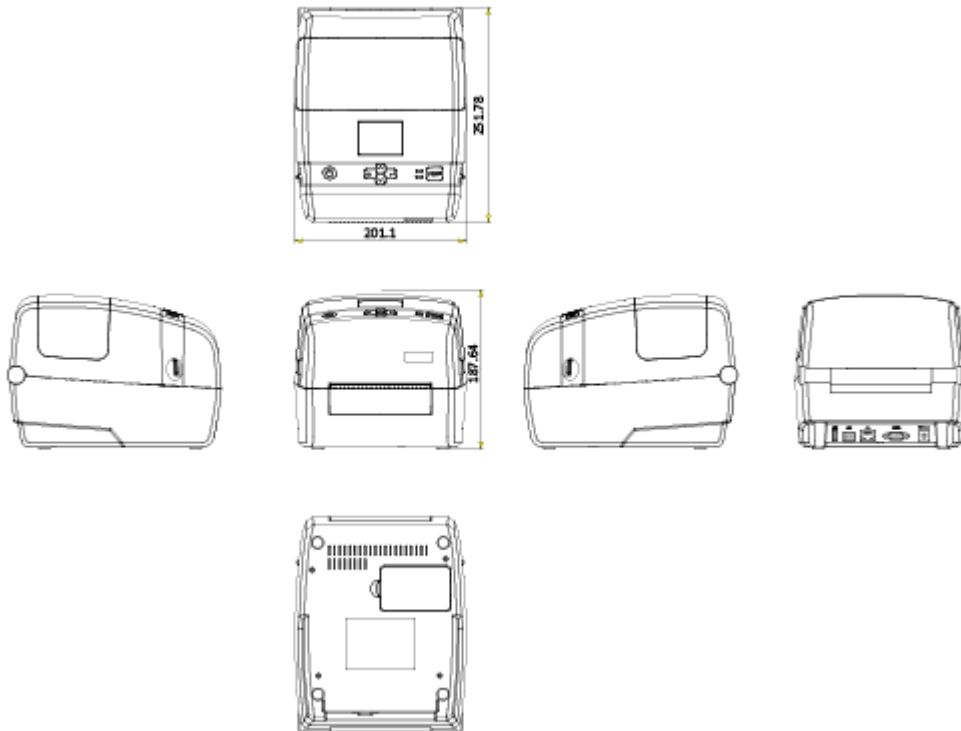

## Chapter 2 Specifications

(2/1)

Item		Parameter		
Type		iD4S	iD4P	
<b>Printing</b>	Printing Method	Direct thermal		
	Resolution	STD 203dpi,OPT 300dpi		
	Max.Printing Speed	5 ips (203dpi)	8 ips (203dpi)	
		4 ips (300dpi)	6 ips (300dpi)	
	Max.Printing Width	108mm(203dpi),106mm(300dpi)		
Max.Pringting Length	2,286mm(203dpi),1,524mm(300dpi)			
<b>Memory</b>	RAM	128MB		
	Flash	256MB		
<b>Programing Language</b>		ZPL-II,EPL-II,DPL		
<b>Detection</b>	Sensor	Print Frame Open Detect, Paper Out Detect, TPH Over Heating Detect, 2 Fixed Position See-through sensor, Full Range Reflective Sensor		
<b>Media</b>	Types	Continuous Paper, Gap, Black Mark, Punched Hole Label		
	Width	1"(25.4)-4.65"(118mm), include the liner		
	Thickness	0.002"(60um)-0.01"(250um)		
	Label Roll Diameter	5"(127mm) Max		
	Core Diameter	0.5"(12.7mm), 1"(25.4mm). 1.5"(38mm)		
<b>Software</b>	Label Design Software	iDPRT Bartender Ultralite		
	Driver	Windows 7,8,10, Server 2008,2012 CUPS for Linux and MAC OS		
<b>Resident Fonts</b>	Bitmap fonts	6, 8, 12, 16, 32, OCR A & B. 90°, 180°, 270° rotatable and 10 times expandable in horizontal and vertical directions		
	TTF fonts	Monotype CG Triumvirate™. 0°, 90°, 180°, 270° rotatable		
<b>Download Fonts</b>	Bitmap fonts	90°, 180°, 270° rotatable and 10 times expandable in horizontal and vertical directions		
	Asian fonts	16x16, 24x24. Traditional Chinese, Simplified Chinese, Japanese, Korean, 90°,180°,270°, rotatable and 8 times expandable in horizontal and vertical directions		
	TTF fonts	90°, 180°, 270° rotatable		

Item		Parameter	
<b>Barcodes</b>	1D	Code 39, Code 93, EAN 8/13 (add on 2 & 5), UPC A/E (add on 2 & 5), I 2 of 5, Codabar, Code 128 (subset A, B, C), EAN 128, MSI, Plessey, Telepen, GS1 DataBar, Standard 2 of 5, Industrial 2 of 5, Code 11, Code 49	
	2D	PDF417, Data matrix code, QR code, Micro PDF417, Aztec code	
<b>Code Page</b>		850, 852, 437, 860, 863, 865, 857, 861, 862, 855, 866, 737, 851, 869, WINDOWS 1250, 1251, 1252, 1253, 1254, 1255, 1257, UTF-8, UTF-16BE, UTF-16LE, DBCS 932 (JIS), 936(GBK), 949 (Koran), 950(BIG5)	
<b>Graphics</b>		Resident graphic file types are BMP and PCX, other graphic formats are converted by the software download	
<b>Interfaces</b>	Standard	USB	USB, USB HOST, RS232, Ethernet
	Optional	RS232, Ethernet, Wi-Fi, Bluetooth	Parallel, Wi-Fi, Bluetooth
<b>Control Panel</b>		Power switch button, FEED button, 2 indicating LEDs	
<b>LCD Display</b>		Not Support	2.4" TFT LCD with Navigation Button
<b>RTC Function</b>		Not Support	Standard
<b>Power Supply</b>		External AC/DC switching power adapter, AC 100V-240V/DC 24V/2A/48W, Peak 5A	External AC/DC switching power adapter, AC 100V-240V/DC 24V/2.5A/60W, Peak 9A
<b>Environment</b>	Operation	5 to 50°C@ humidity 25% to 85% non-condensing	
	Storage	-40 to 60°C@ humidity 10% to 90% non-condensing	
<b>Physical</b>	Dimension(L*H*W)	247*210*177mm	
<b>Characteristic</b>	Weight	About 1.8 kg	
<b>Options &amp; Accessory</b>		Peeler Module, Cutter Module, External Label Roll Holder	
<b>Agency Approval</b>		CE EMC (EN 55022 Class B), FCC EMC (Class A), CCC, RoHS	

## Chapter 3 Installation & Usage

### 3.1 Media Loading

#### 3.1.1 Loading the Roll

1. Pull and lift the cover. (eg:iD4P)



2. Pull the roll holders open and place the roll between them.

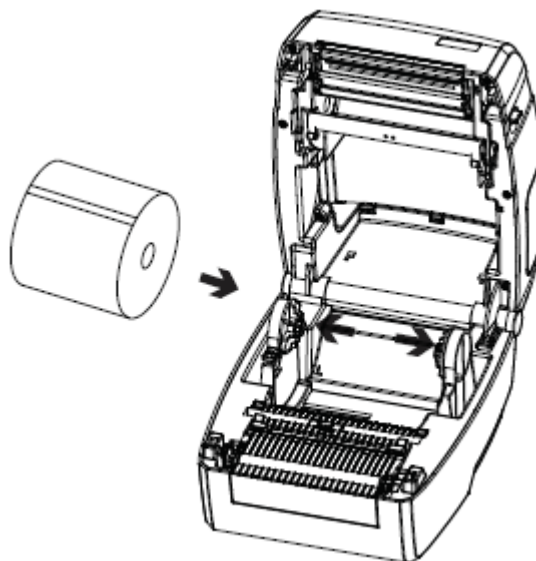

3. Press down the locking tab.

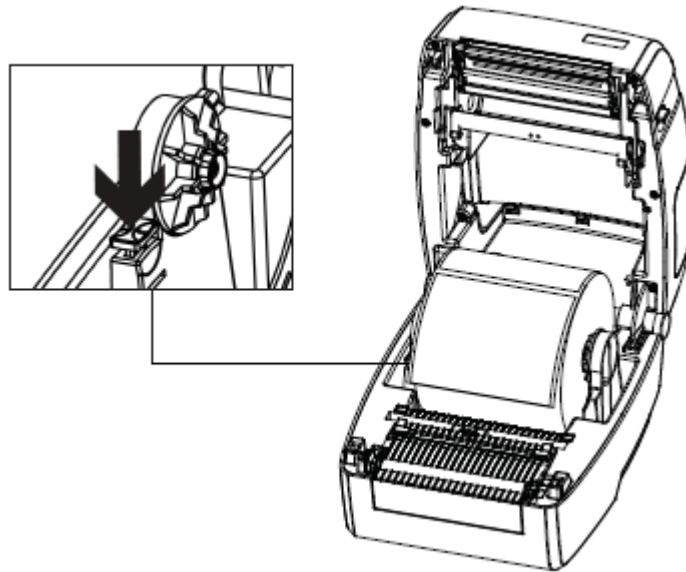

4. Pass the labels through label guides and adjust label guides to label's width.

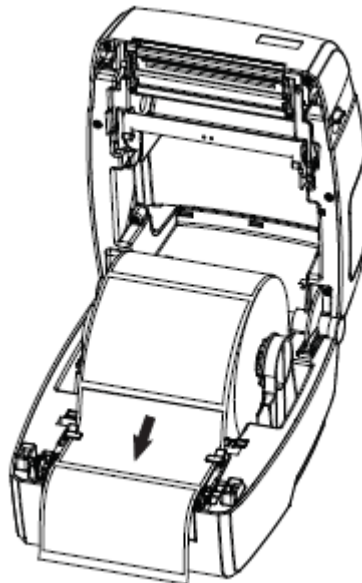

5. Press the lock and close the cover slightly.

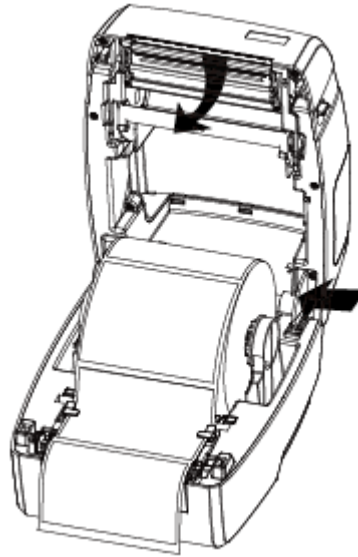

6. Press down the cover until it snaps closed.

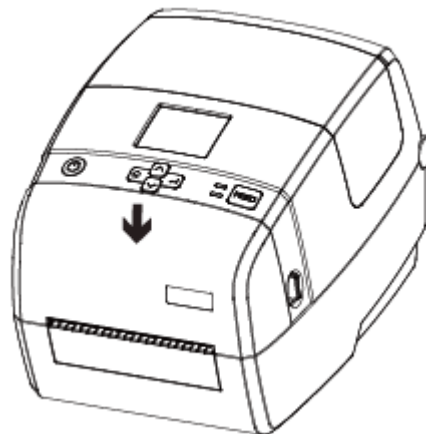

## 3.2 Power Connection

1. Connect the AC adapter to power receptacle.
2. Connect the power cord to AC adapter.
3. Connect the other end of power cord to the outlet.

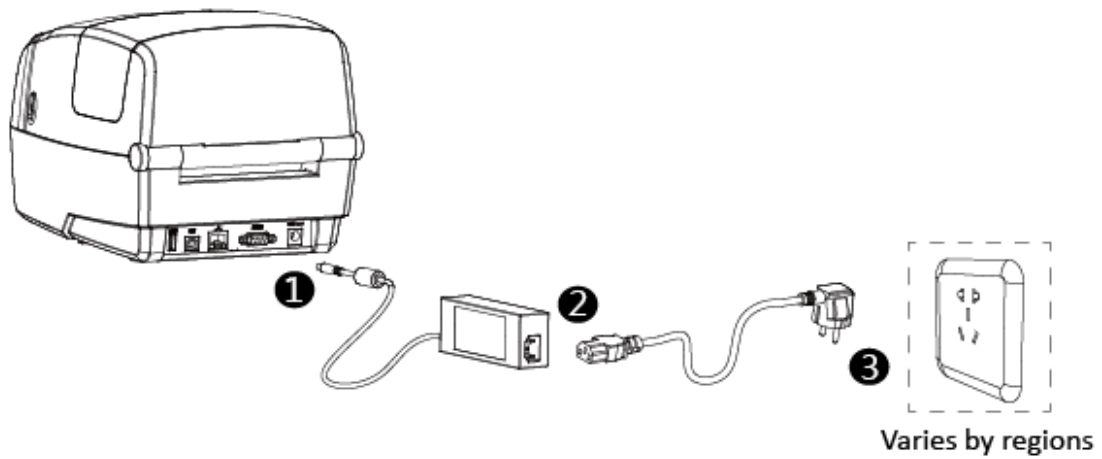

### Caution:

- Use the original power adapter only. Avoid the damage caused by charging improperly.
- Please unplug the printer power cord if it is not in use for a long time.

## 3.3 Peripherals Connection

### 3.3.1 Interface Cable Connection

1.The standard for the printer's interface cable shows as follows:

- USB A-Type cable
- USB B-Type cable
- RS-232C cable
- RJ45 cable

2.Based on your own need, follow the instructions to connect the cable.

- 1) Make sure the printer's power is off.
- 2) Please plug in the cables.
  - Insert the USB A-Type cable into the USB (type A) interface.
  - Insert the USB B-Type cable into the USB (type B) interface.
  - Insert the RS-232C cable into the serial interface.
  - Insert the RJ45 cable into the ethernet interface.

### 3.3.2 Bluetooth Connection

PDA with Bluetooth interface, laptop and other information terminals can drive the printer.

Instructions show as follows:

1. Power on the printer.
2. Primary device searches for outer Bluetooth devices.
3. If there are other Bluetooth devices, select printer's name.
4. Finish pairing.

If you need more detailed information of pairing methods, please refer to the instructions of Bluetooth device.

After pairing, primary devices with virtual Bluetooth interface (smart phone, tablet, pocket PC, palm, notebook) can drive the printer iD4P or iD4S to print labels through virtual Bluetooth interface.



**Note: The original code is 0000.**

### 3.4 Detection

When printing paper, the moveable label sensor is used to detect paper. The label sensor moves differently when using various kinds of paper. If user moves the sensor improperly, paper may not be detected, therefore the printer could not print paper. The following instructions tell users how to use label sensor correctly. Please read it carefully.

#### 3.4.1 Continuous Paper

When printing continuous paper (Figure 1), the sensor shall be aimed at the left triangle below (Figure 2), which is the original position.

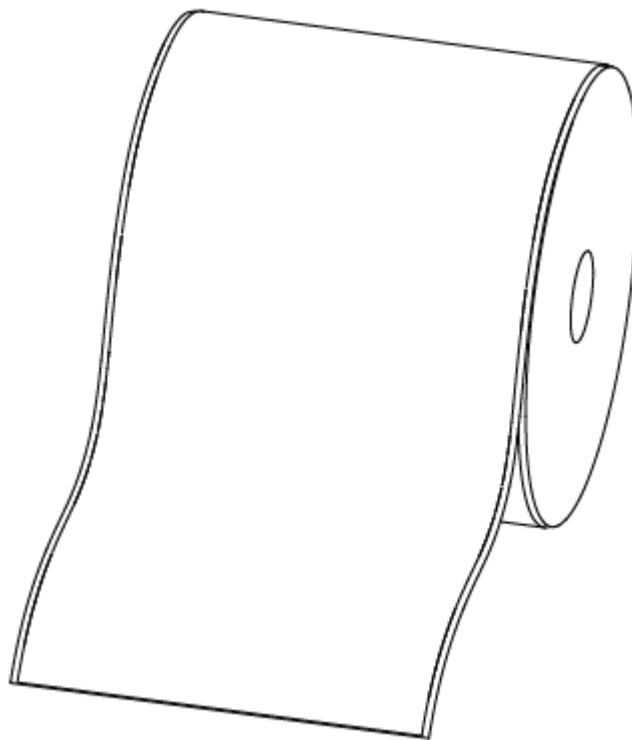

Figure 1 (Continuous Paper)

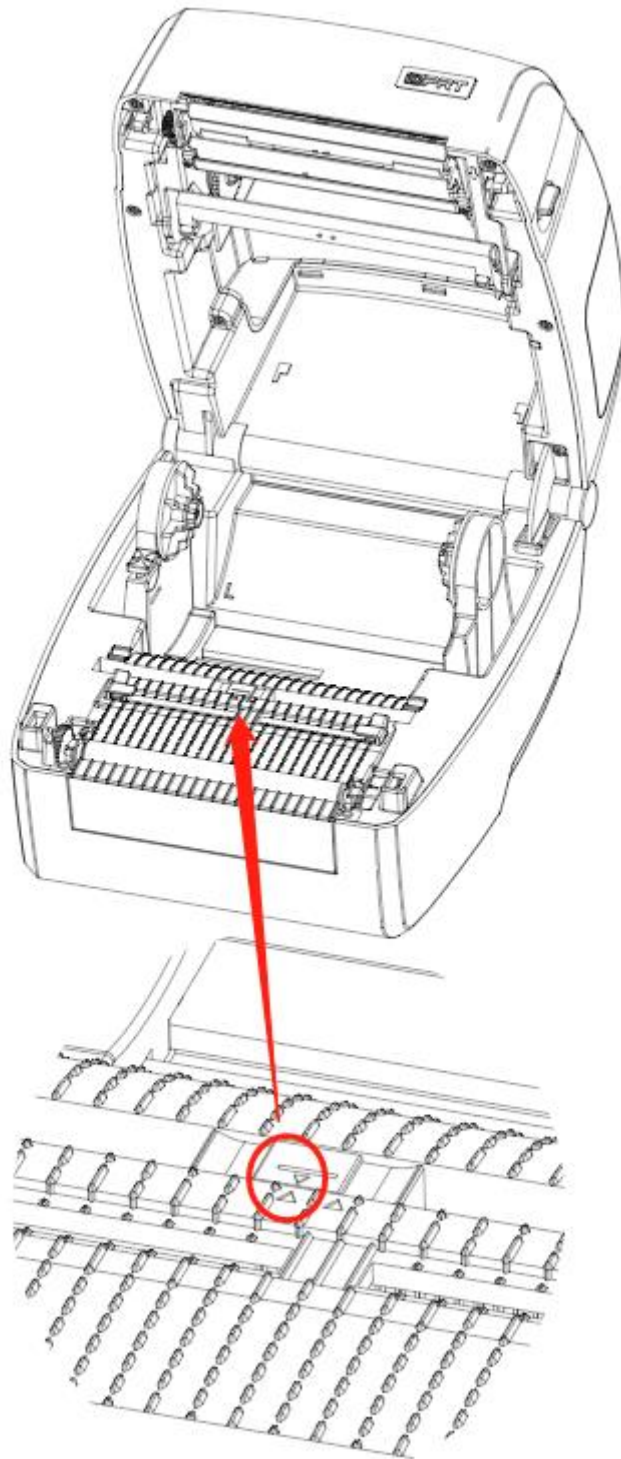

Figure 2 (Left)

### 3.4.2 Labels

When printing labels (Figure 3) or double-row labels (Figure 4), the sensor shall be aimed at the left triangle below (Figure 5), which is the original position.

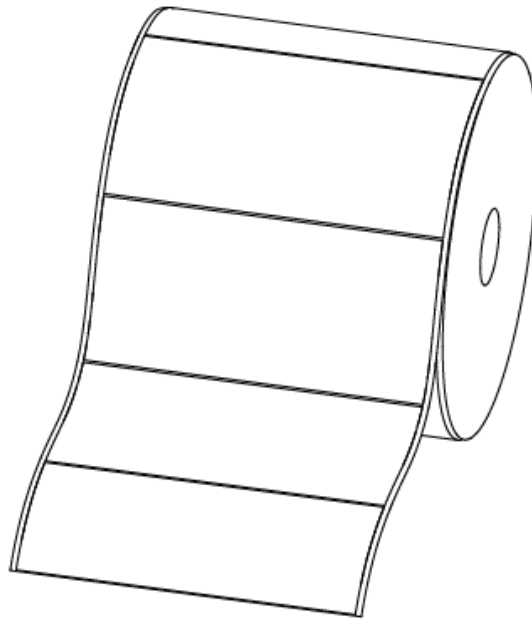

Figure 3 (Labels)

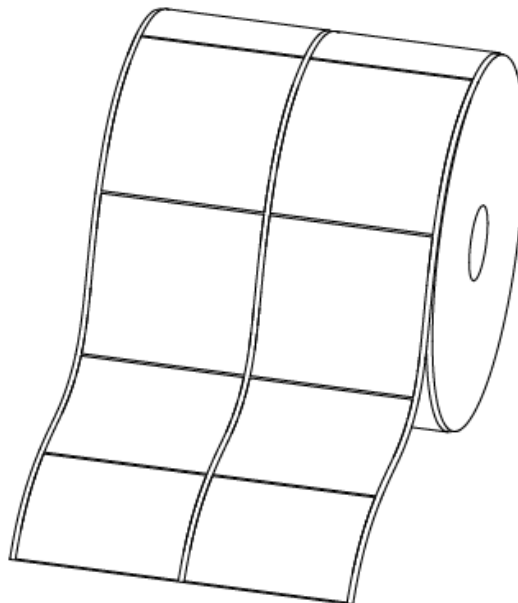

Figure 4 (Double-row Labels)

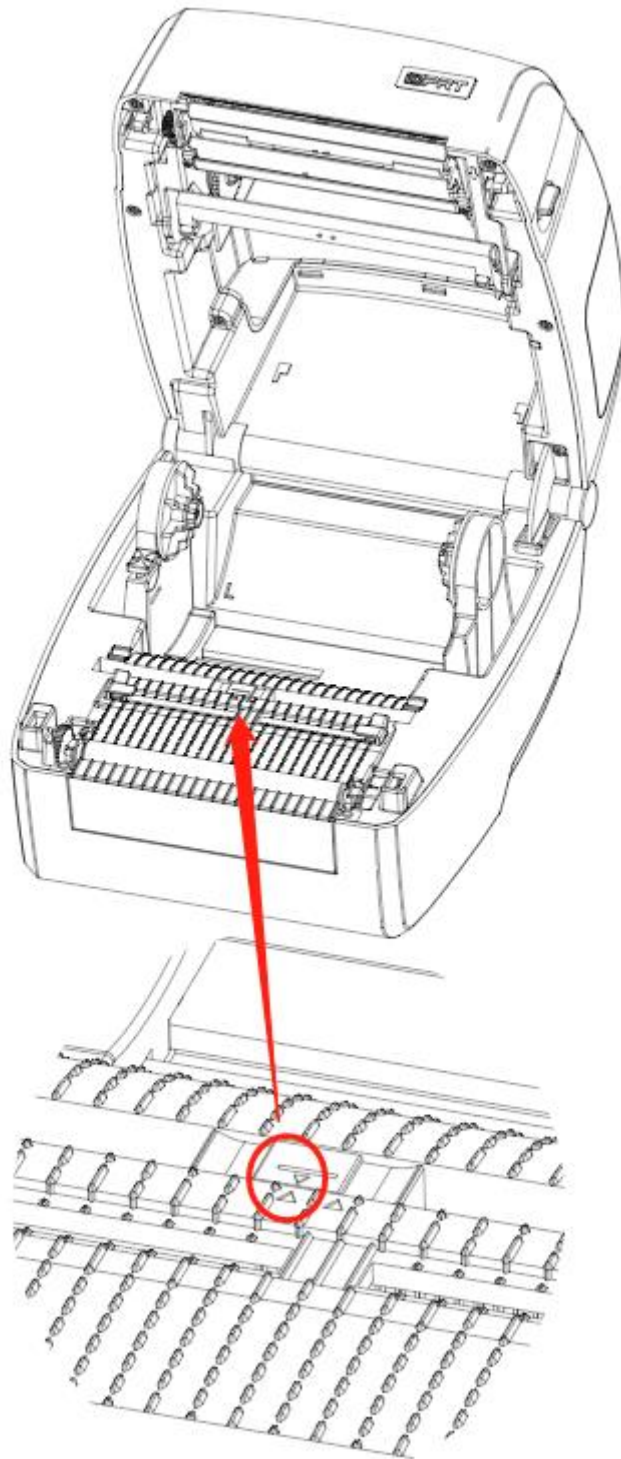

Figure 5 (Left)

### 3.4.3 Punched Hole Label

When printing punched hole labels, move the sensor until it's aimed at the right triangle below (Figure 6).

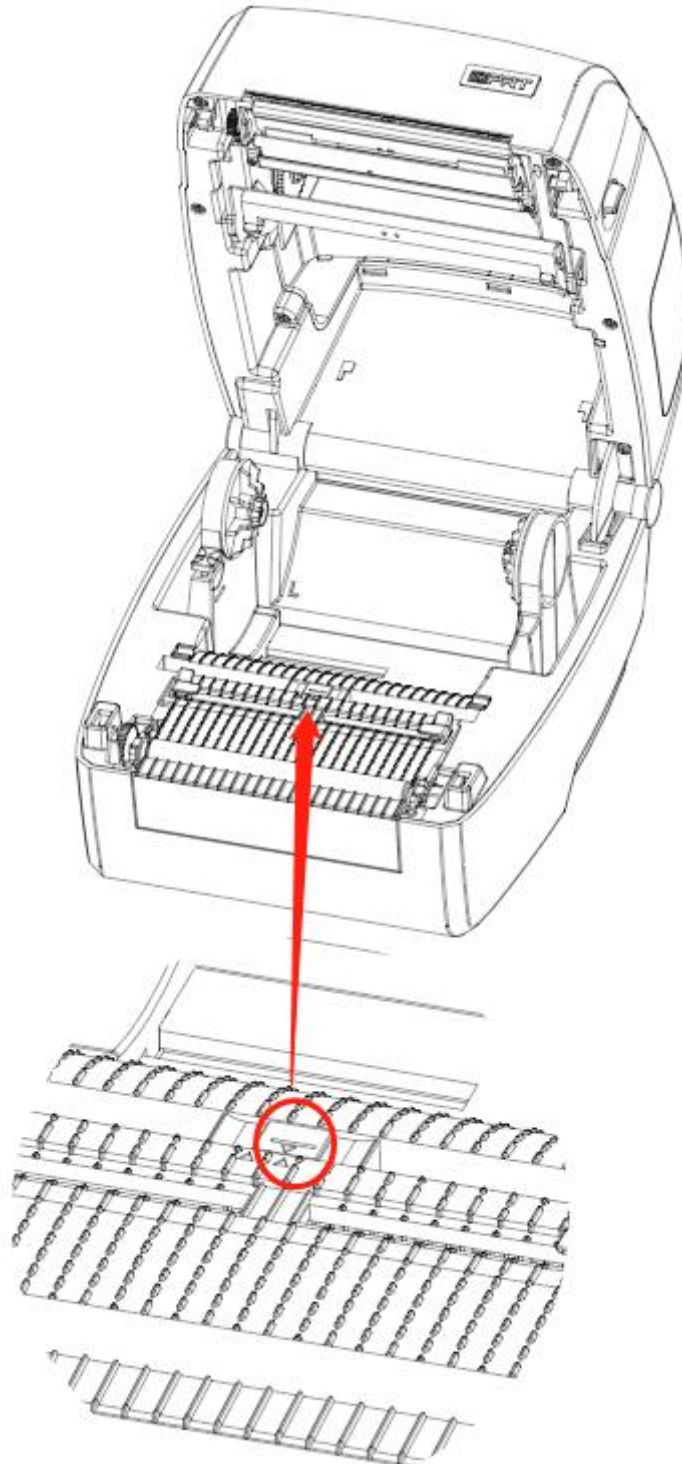

Figure 6 (Right)

### 3.4.4 Blackmark Paper

When printing blackmark paper (Figure 7), the sensor shall be aimed at the position of black mark (Figure 8).

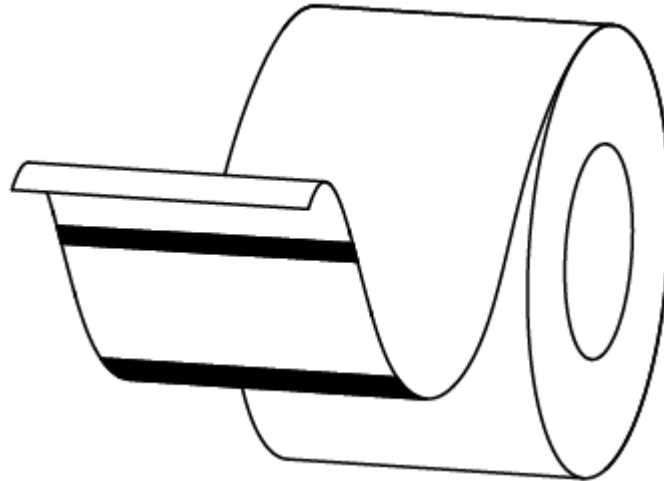

Figure 7 (Blackmark Paper)

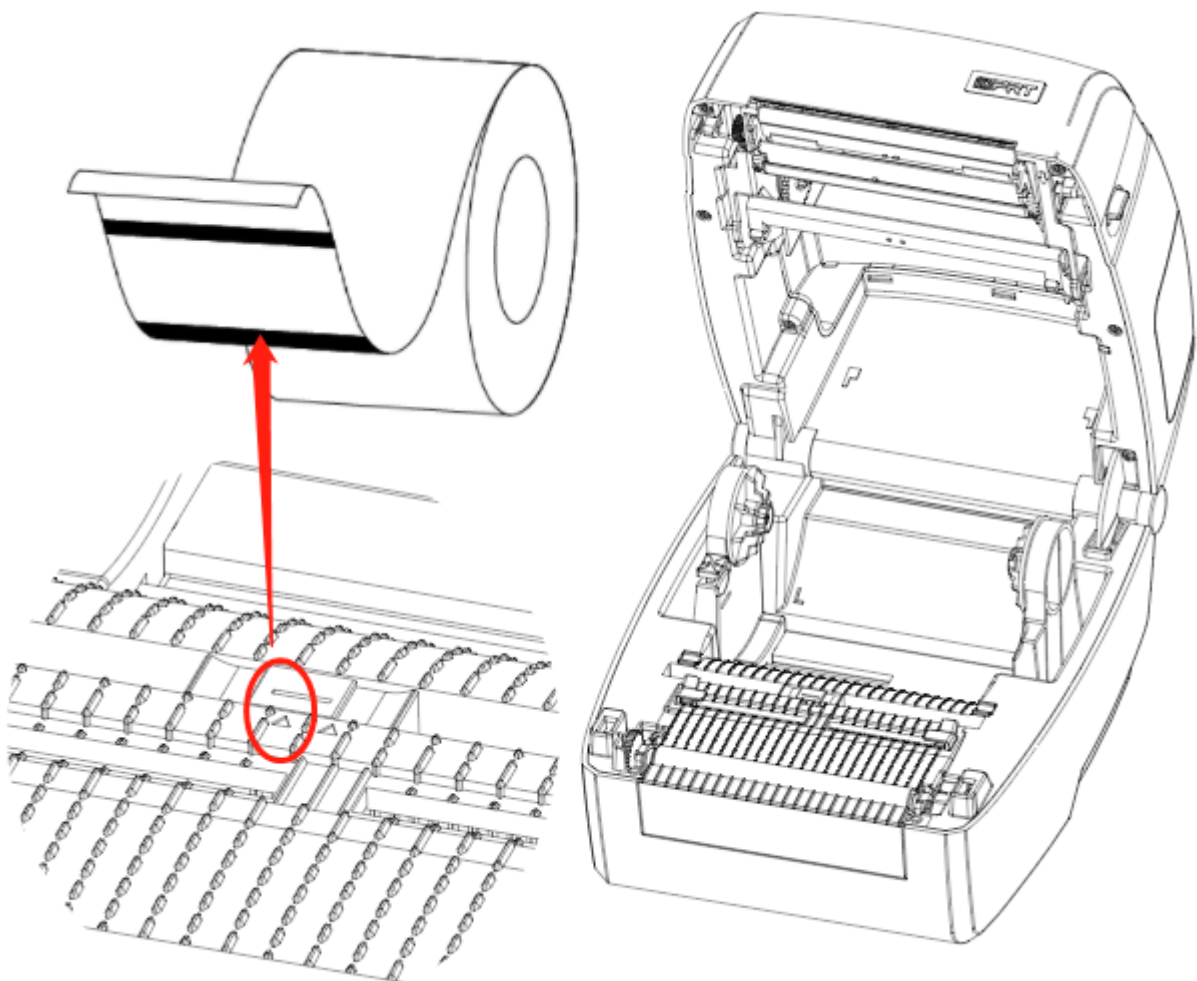

Figure 8 (aimed at blackmark's position)

## 3.5 Operation Panel

### 3.5.1 Panel Introduction

The panel indicates the printer's operating status and allows the user to control basic printer operation.

#### 1.Power Button



Much more detailed information is provided in "3.6.1 Power On/ Power Off".

#### 2.Feed Button





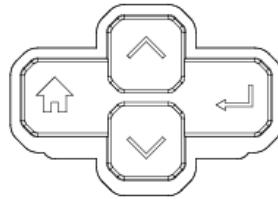

Much more detailed information is provided in "3.6.2 FEED Button".

#### 3.Directionals Pad (only for printer iD4P)



It is included by up arrow button, down arrow button, menu button and enter button.

-  Up Arrow Button: Common uses are to scroll through choices, navigating to the left or the previous choice.
  -  Down Arrow Button: Common uses are to scroll through choices, navigating to the right or the next choice.
  -  Menu Button: Common uses are to back to the previous menu or to cancel the settings.
  -  Enter Button: Common uses are to navigate to the sub-menus, change the values or to save the settings.
-

#### 4.Display (only for printer iD4P)

It is divided into idle display, home menu display, sub-menu displays and operating displays.

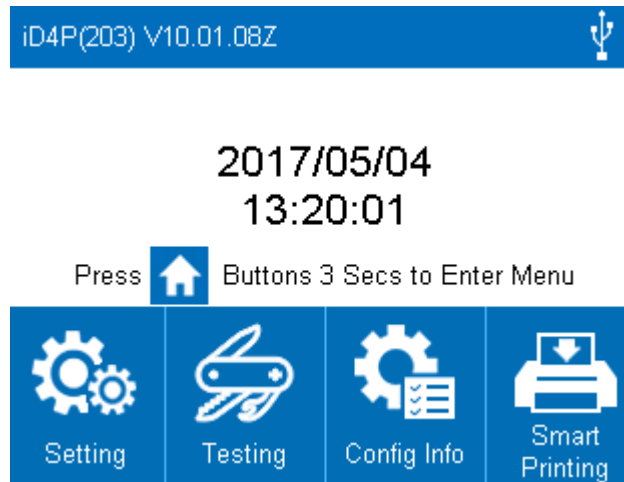

Idle Display

- When the printer is power on, the idle display will appear.
- It contains printer's name, version number of the firmware, time and menu.

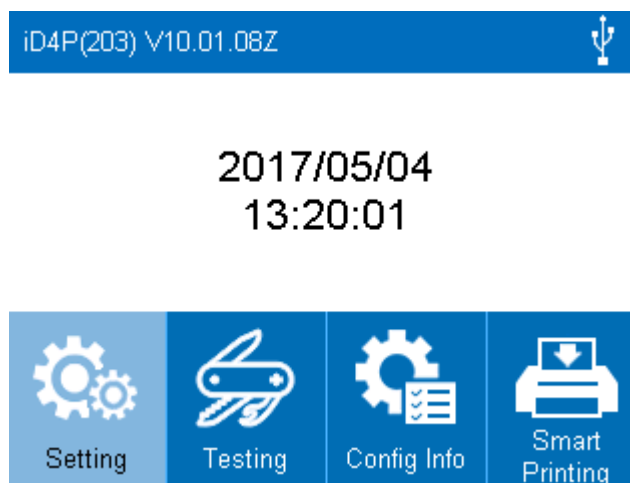

Home Menu Display

- When the printer is ready, press menu button for three seconds, and printer will come into home menu.
- User can operate the printer by display in home menu.

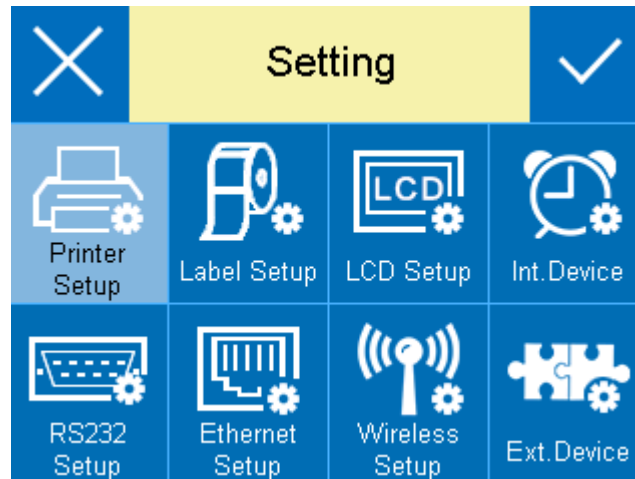

#### Sub-menu Display

- There are numerous sub-menu displays and user can switch them by menu button and enter button.

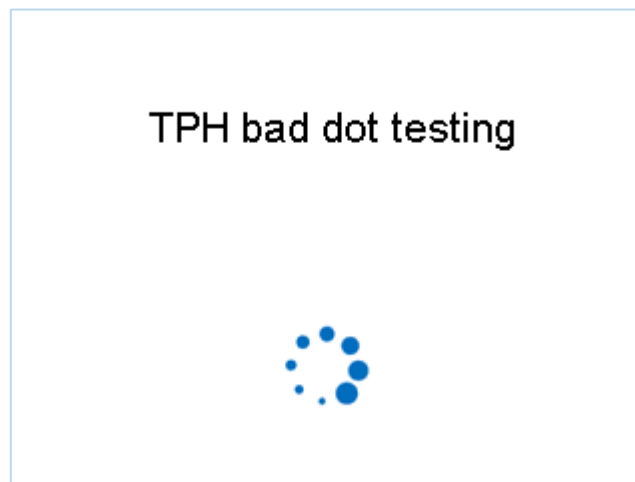

#### Operating Display

- When operating display appears, it means that printer is carrying the command that user has sent. After finishing the task, printer will return to the sub-menu display.



Note:

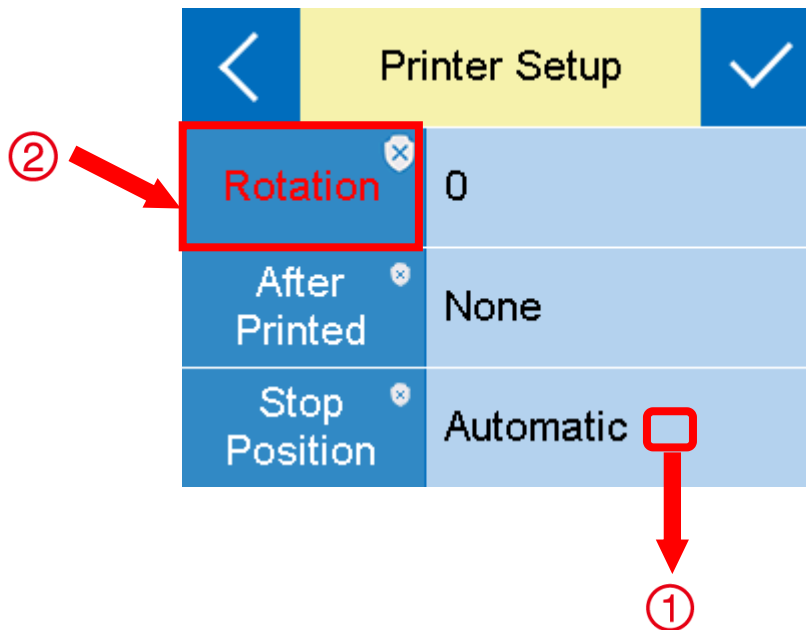

① The item with red frame: When the item is white, the relevant values could be changed both by display operation and software instructions. When the item turns yellow, the relevant values have been protected and can only be changed by display operation.

② User can change the item into another status by clicking the corresponding value.

### 3.5.2 Display Operation



Note:

- The display operation of printer iD4P is controlled by directional pad.
- The highlighted item represents that user has chosen the item needed.

In the following instructions, the example will be taken to show user how to operate the printer.

Changing the speed of the printer:

1. Press the power button to open the printer's power.



2. Press the menu button for three seconds to enter the home menu, then choose the "Setting" item.



2017/05/04  
13:20:01



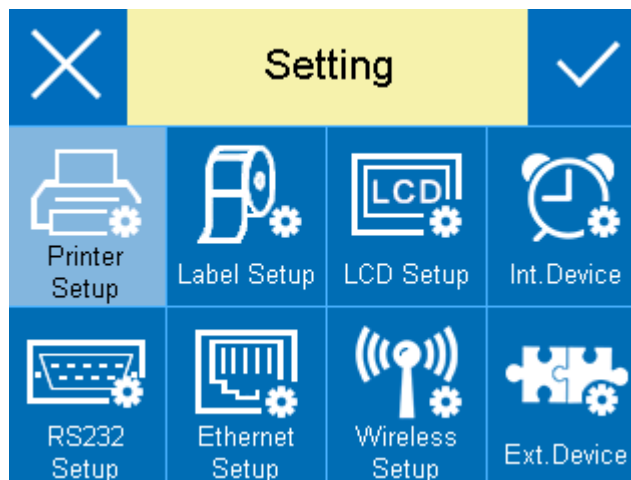

3. Enter the setting menu, then choose the "Printer Setup" item.

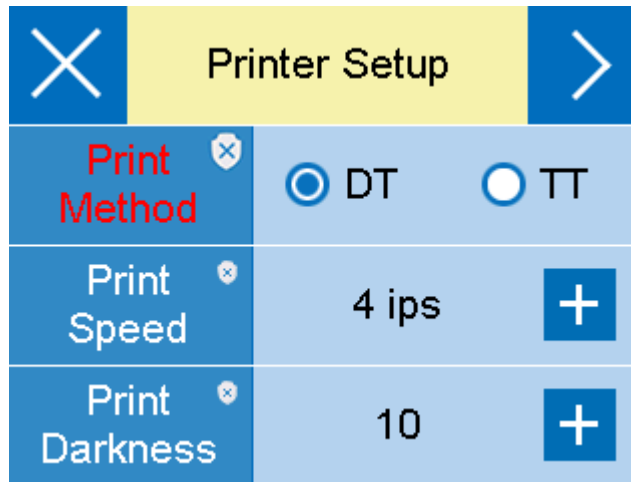

4. Enter the "Printer Setup" menu.



5. Move the selection highlight to "Print Speed" item by down arrow button  . Then

change it into the value needed by enter button  .

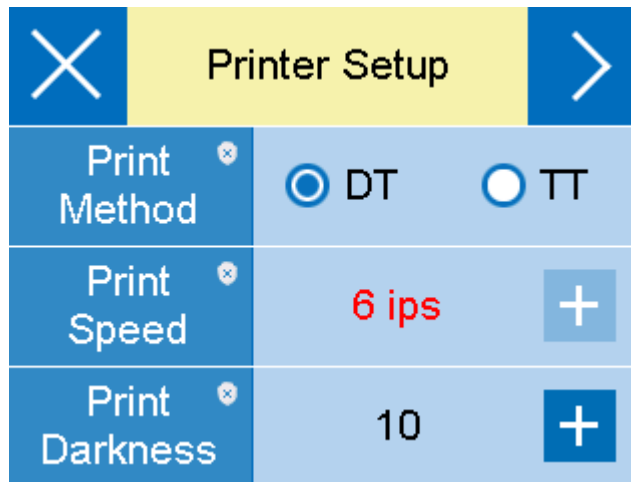

6. Press the tick to save the values that have been changed.

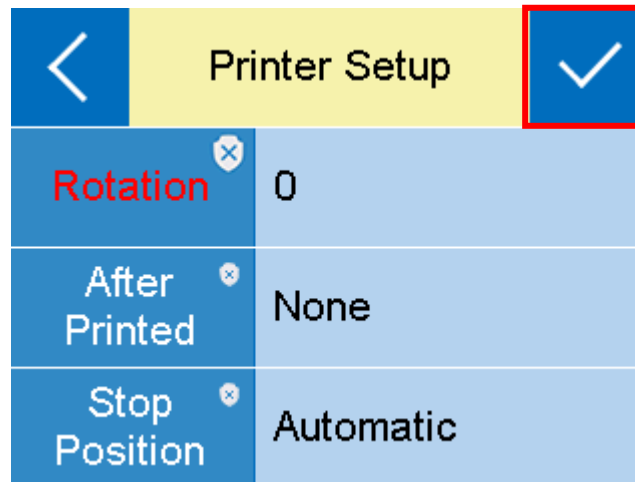

Finishing the above operation, user has changed the speed of the printer successfully.



**Note:**

- Much more detailed information of display menu needed, please refer to the appendix in the end.
- Pictures above are for your reference, and the display shows as the real printer does.

### 3.5.3 Indicator Instructions

#### 1. Power light

Color	Action	Indicating Status
x	x	The printer is off
Green	On	Normal operation
Green	Slow flash	Dump mode

#### 2. Status light

Color	Action	Indicating Status
x	x	The printer is off/standby/printing
Red	On	Head up/paper out
Red	Quick flash	Paper jam/label' s separation
Orange	On	Ribbon out
Orange	Slow flash	Printing pause
Green	On	Label calibration
Green	Slow flash	Wait on demand
Green	Quick flash	Receiving data

#### 3. Paper Container light

Action	Indicating Status
On	Paper out/Paper jam/label's separation
Off	Head up/error elimination



**Note:**

**Quick flash → 0.2 second / every cycle**

**Slow flash → 1 second / every cycle**

## 3.6 Basic Function

### 3.6.1 Power On/ Power Off

- When the printer is off, press the power button once, and printer will power on.
- When the printer is on, press the power button for three seconds. After ringing twice, the printer will power off.

### 3.6.2 FEED Button

- When the printer is ready, press the feed button, and printer will automatically feed a label under "Label Mode". Press the feed button, and the printer will feed the fixed distance under "Continuous Mode".
- When the printer is printing, press the feed button once and it will stop the printing job. Press the feed button for three seconds and it will cancel the printing job.
- When the printer pauses, press the feed button once and it will continue the printing job. Press the feed button for three seconds and it will cancel the printing job.
- When the printer is in dump mode, press the feed button once, then back to the normal printing mode.
- When the indicator status flashes slowly(green), press the feed button once and printer will print a label.

### 3.6.3 Quick Calibration

**Users must carry out the calibration under the conditions below:**

- The first time to use the printer since installation;
- The first time to use the printer since sensor cleaning;
- Reuse the printer when it has not been used for a long time;
- Change a new type of media;
- Printer cannot recognize the mark;
- Huge change of the operating environment;

**Calibration method:**

- Carry out the calibration manually.

When printer is ready, press the FEED button for 3 seconds until the status indicator (Green) flashes twice. Then release the button, and printer will start to do the calibration. When printer does the calibration under Continuous Media Mode, the calibration is invalid.

- Carry out the calibration by printer utility tool.

Please refer to detailed information in "Chapter 6 Printer Utility Tool Instructions".



**Note:** After the quick calibration, users could open the printer cover to pull back the learned paper in avoid of paper wasting.

### **3.6.4 Print Self-test Page**

The self-test checks the printer's current settings, status and whether the printer has any problems or not.

#### **1. Printing Manually**

- 1) Make sure the roll is loaded properly.
- 2) Make sure the top cover of the printer is closed properly. Then turn on the printer.
- 3) When the printer is ready, press the feed button continuously. As soon as the indicator flashes (green) once, loosen the button. Then the printer starts to print the self-test page.

#### **2. Printing by Windows Driver Program**

- 1) Install the Windows Driver program.
- 2) Set the "Interface" as the type you use.
- 3) Use the Windows Driver Program to print out the "Self-test page".
- 4) Please refer to "Chapter 7 Seagull Windows Driver Instructions" for more detailed information.

#### **3. Printing by BarTender Ultralite Program**

- 1) Install the BarTender Ultralite program.
- 2) Edit a new label and print it.
- 3) Please refer to "Chapter 8 BarTender Ultralite Instructions" for more detailed information.

## Chapter 4 Interface

### 4.1 USB Interface

#### 1.USB (Type A)

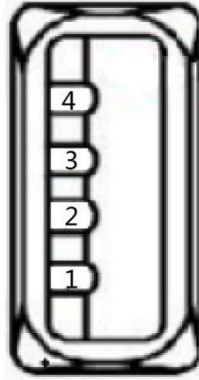

PIN	SIGNAL NAME
1	VBUS
2	D-
3	D+
4	GND

#### 2.USB (Type B)

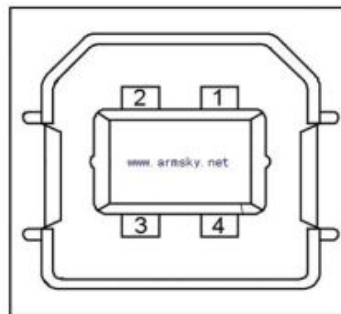

PIN	SIGNAL NAME
1	VBUS
2	D-
3	D+
4	GND

## 4.2 Other Optional Interfaces

### ■ Serial Port

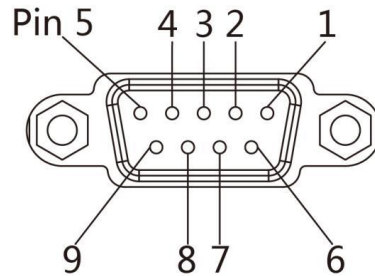

PIN	SIGNAL NAME	SIGNAL DIRECTION
1	+5VDC	OUTPUT
2	RXD	OUTPUT
3	TXD	INPUT
4	DTR	INPUT
5	GND	GROUNDING
6	DSR	OUTPUT
7	RTS	INPUT
8	CTS	OUTPUT
9	-	NO CONTACT

### ■ Ethernet Port

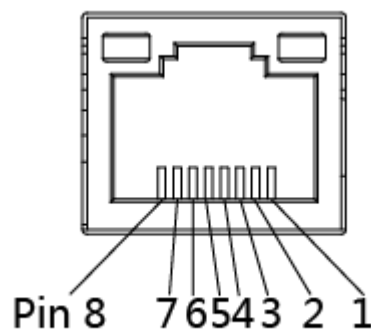

PIN	SIGNAL NAME
1	TX+
2	TX-
3	RX+
4	-
5	-
6	RX-
7	-
8	-

## Chapter 5 Maintenance & Adjustment

Adhesives and coatings of the media can transfer to the printer parts over time along the media path including the thermal print head and media sensor. This build-up can accumulate dust and debris. Failure to clean the print head, media path, and media sensor could result in inadvertent loss of labels, label jams and possible damage to the printer.

**Note:**

- Make sure to turn off the printer prior to cleaning.
- As the print head gets hot during printing, if intending to clean the print head, turn the printer off and wait approximately 2~3 minute before commencement.
- When cleaning the print head, take care not to touch the heated portion of the print head. Print Head is susceptible to damage from static electricity, etc. So it is strongly recommended to wear hand gloves during cleaning progress.
- Take care not to allow the print head become scratched and/or damaged in any way.

### 5.1 Cleaning Media Sensor

Debris or dirt on the paper sensor can cause a miss-read or unstable detection of the label gap. Clean with a cotton bud dampened with alcohol.

### 5.2 Cleaning Thermal Print Head

Thermal Paper stock on the print head, which degrades print quality. Clean the print head with methanol or isopropyl alcohol and a cotton bud. Do not touch the heating elements with your fingers.

- 1) Open the Printer Cover and then use the cleaning pen to clean the head in the direction from the center of the head to two sides.
- 2) After cleaning the head, do not use the printer until the alcohol used for cleaning evaporates completely (1~2 min) and the printer has completely dried.
- 3) Perform the cleaning process each time the paper roll is replaced to prevent print quality deterioration.

### 5.3 Cleaning Roller and/or Paper Path

- 1) Open the printer cover and then remove the paper.
- 2) Remove any dust or foreign substance using dry cloth or cotton swab.
- 3) Soak the cloth or cotton swab in alcohol for medical use and use it to remove adhesive foreign substances or other pollution materials.
- 4) After cleaning the parts, do not use the printer until the alcohol evaporates completely (1~2 min) and the printer has completely dried



**Note: Clean the parts when print's quality or label detection degrades.**

# Chapter 6 Printer Utility Tool Instructions

## 6.1 Installation Preparation

Download application program in CD. eg: iDPRTUtility.exe

## 6.2 Usage



**Note:** The screen may vary slightly by different operating systems and models. Take printer iD4P as example. Please refer to printer iD4P when using printer iD4S.

1. Install “iDPRTUtility.exe”, then open it.

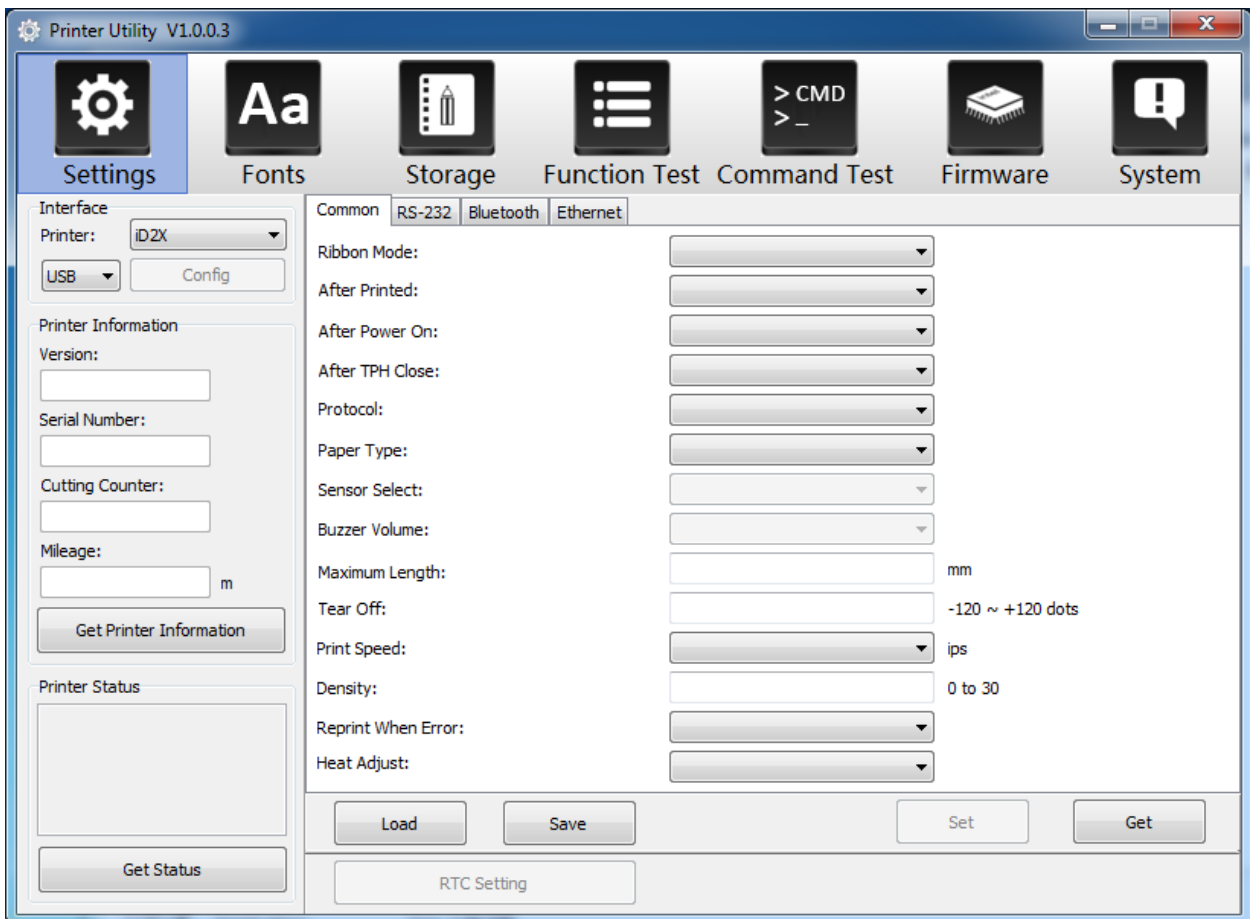

2. Click “Settings”, choose the printer model.

(1) Set up the interface needed. (range: USB, COM, LPT, ETH)

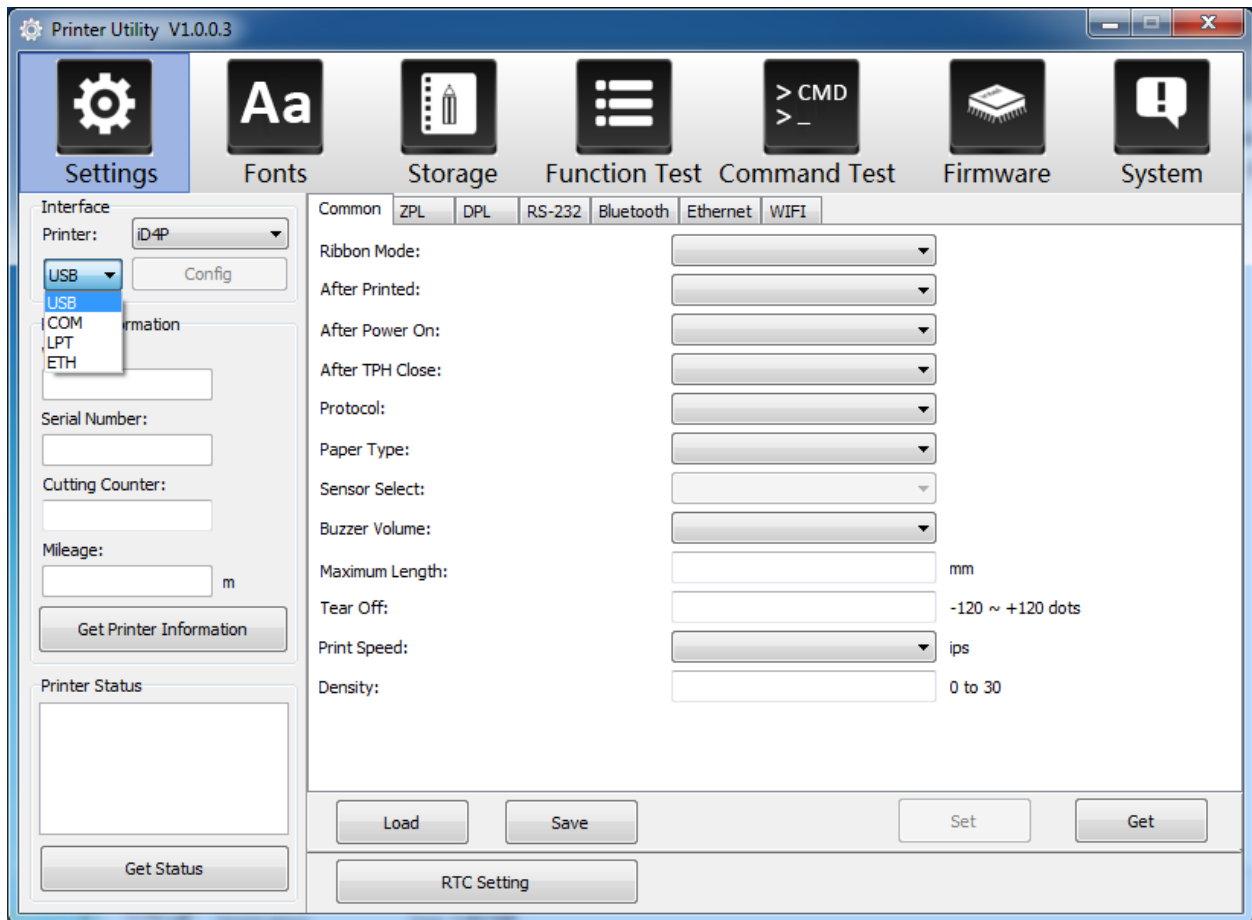

(2) Click “Get Printer Information”, and printer information will show in the above.

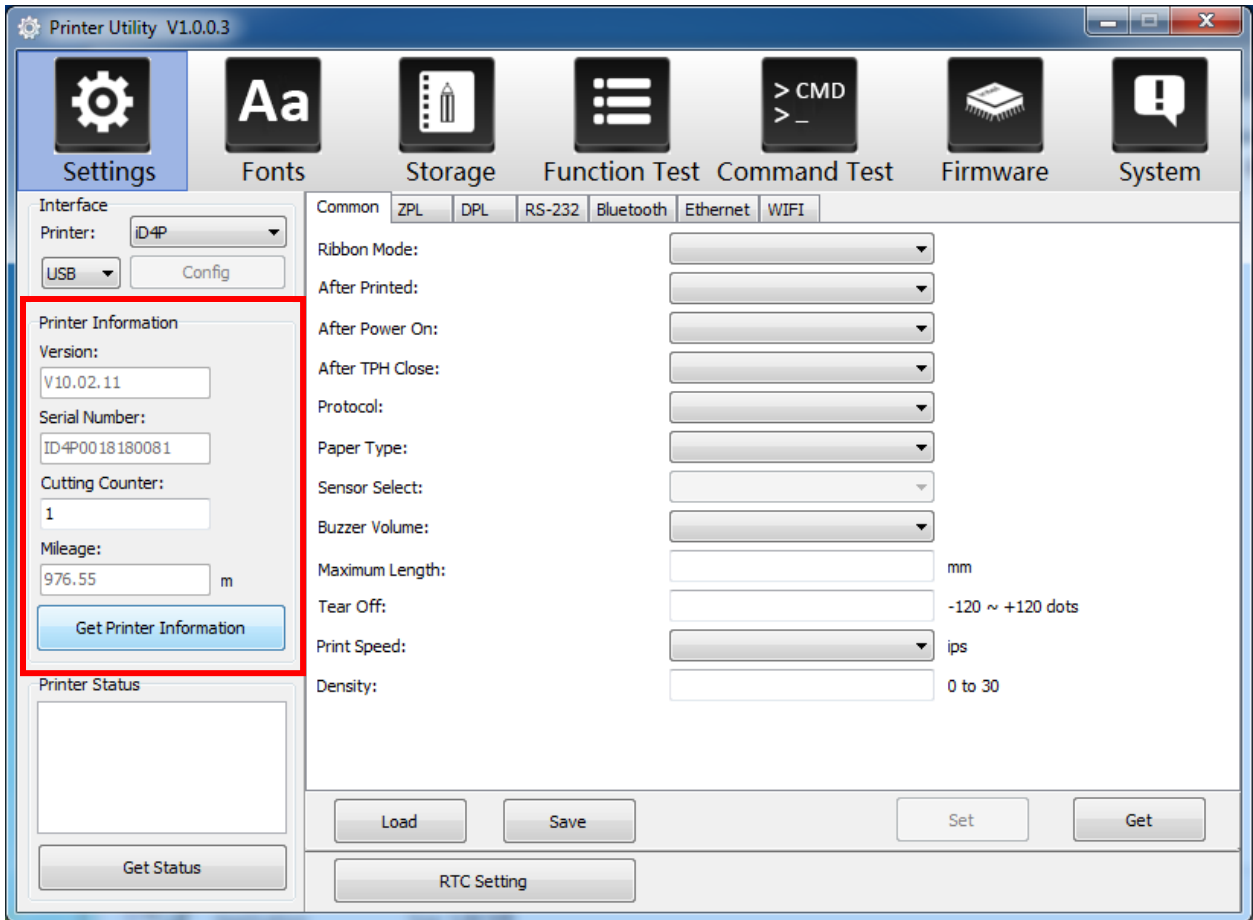

(3) Click “Get Status”, and printer status will show in the above.

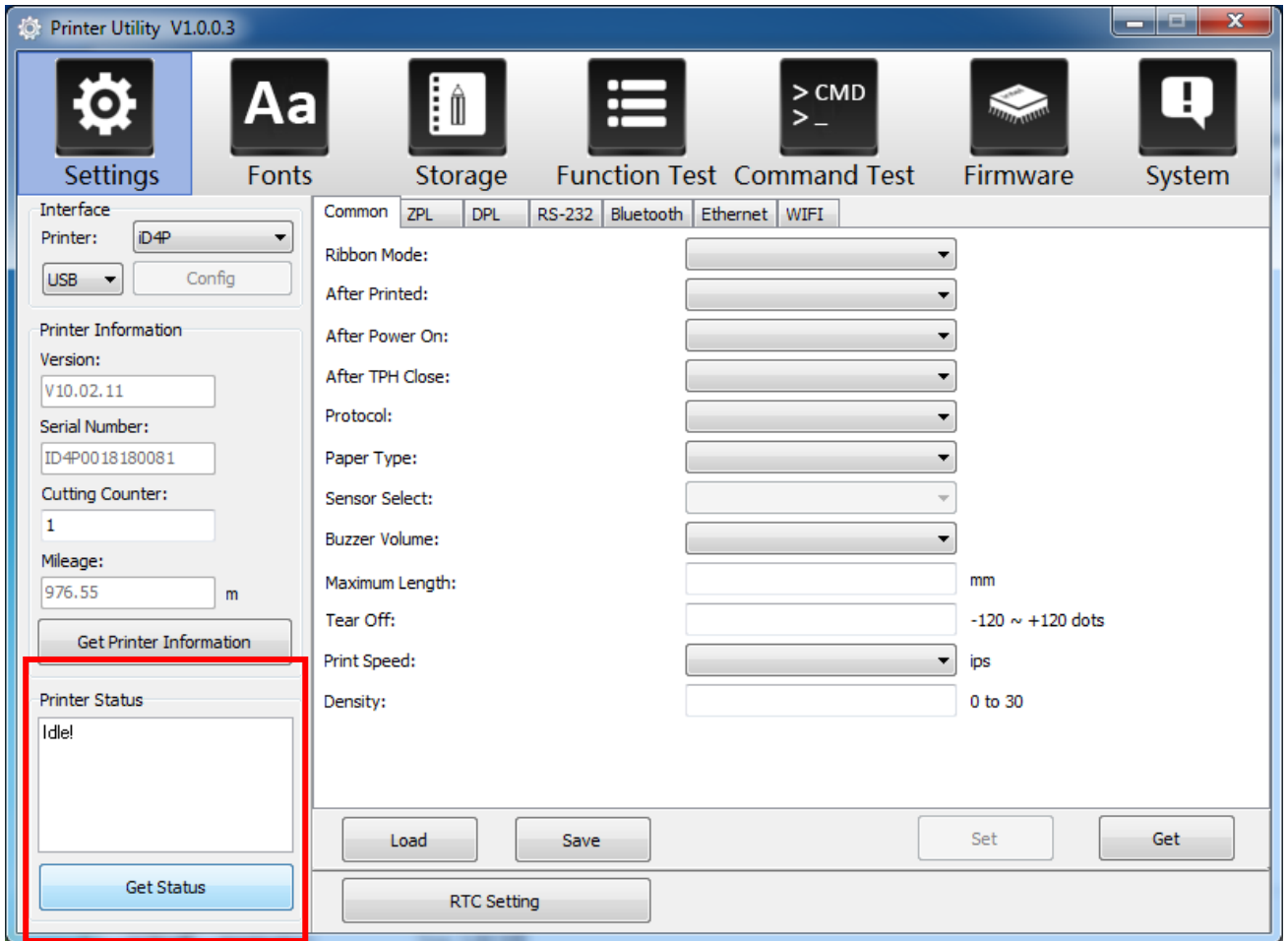

(4) Choose “Common” and click “Get”. In this menu, user can get the information the protocol, media sensor, speed, density and so on.

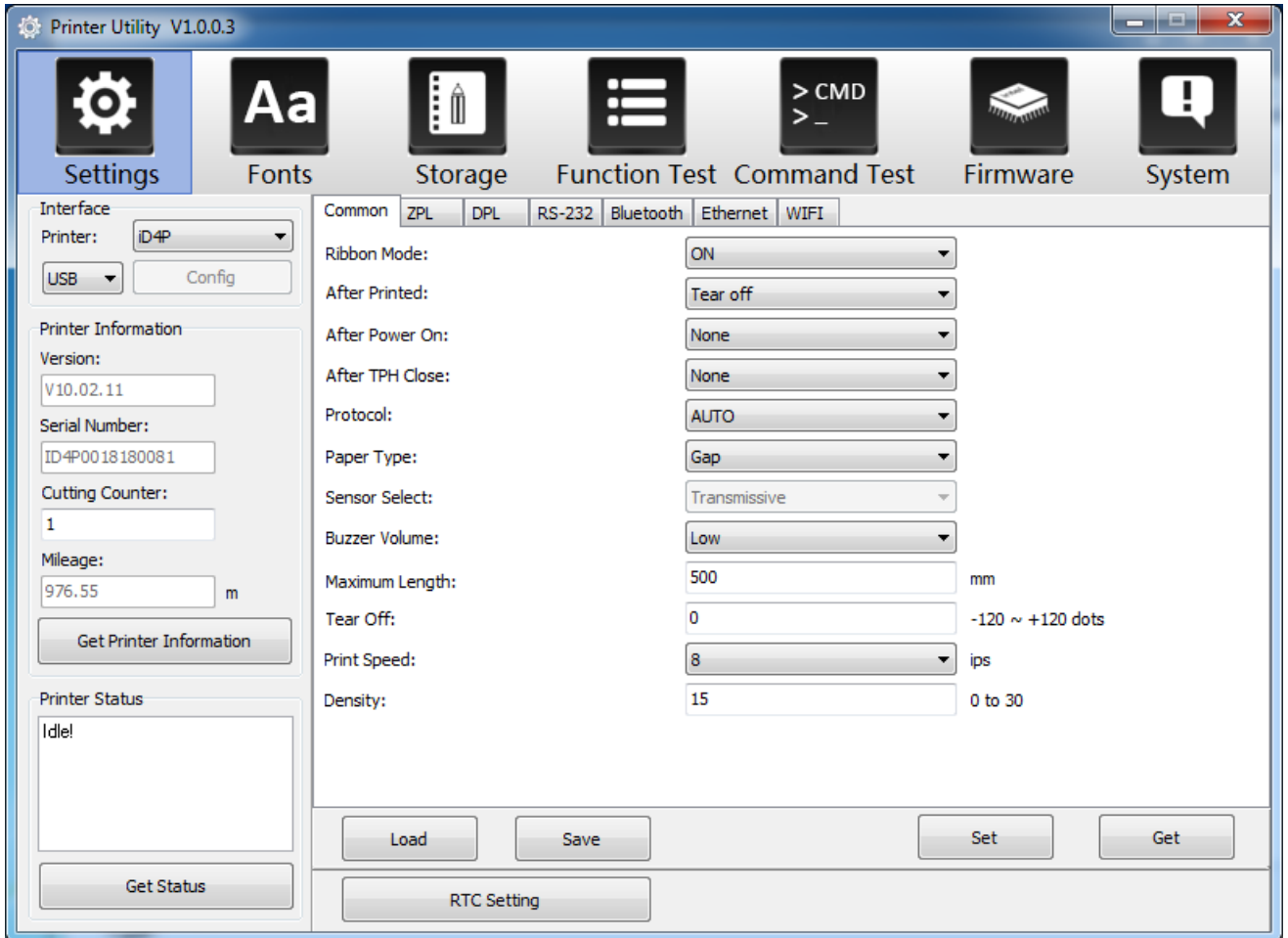

(5) Click “RS-232”, then set up the baud rate, data bits, parity and flow control.

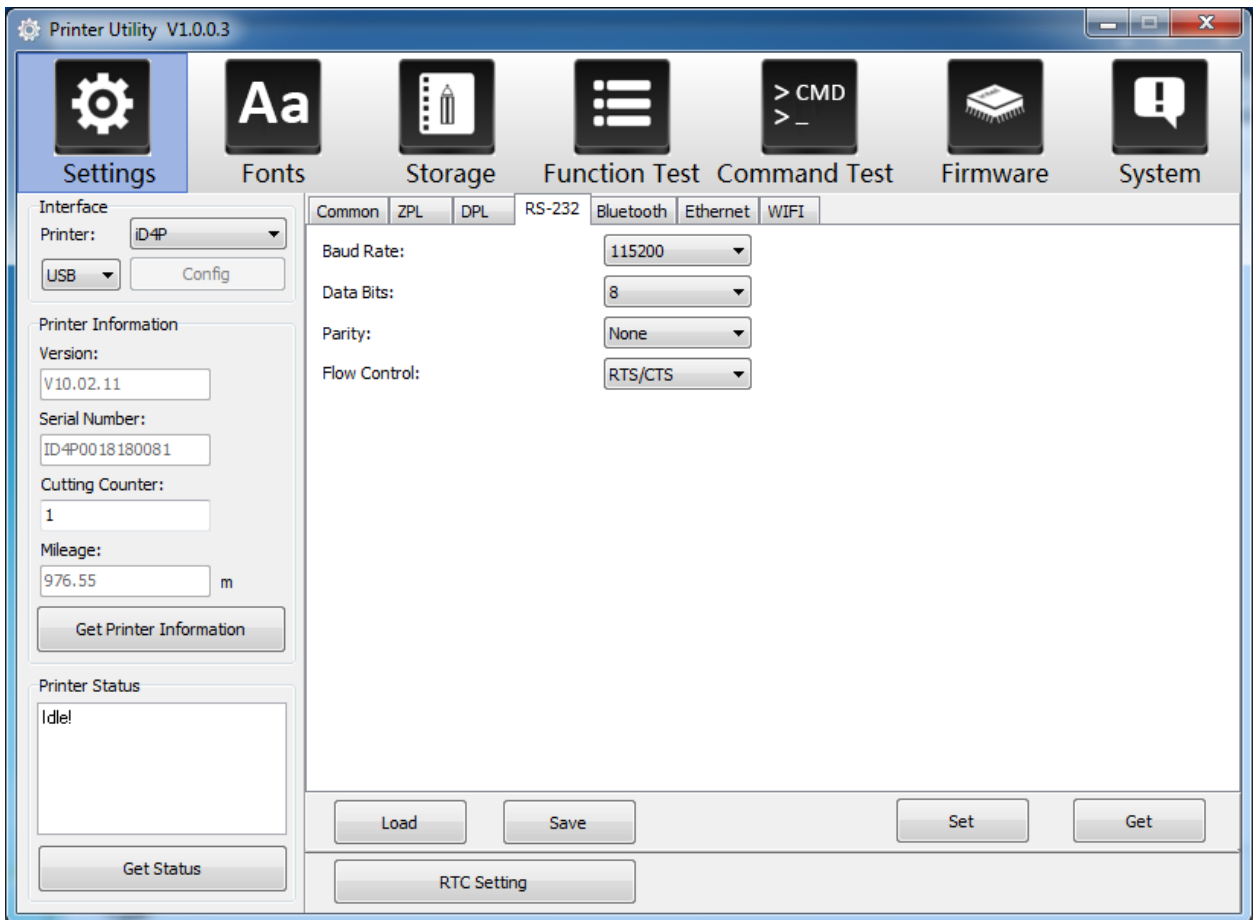

(6) Click “Bluetooth”, then set up the Bluetooth name and password. Click “Get” to gain the values of Mac address.

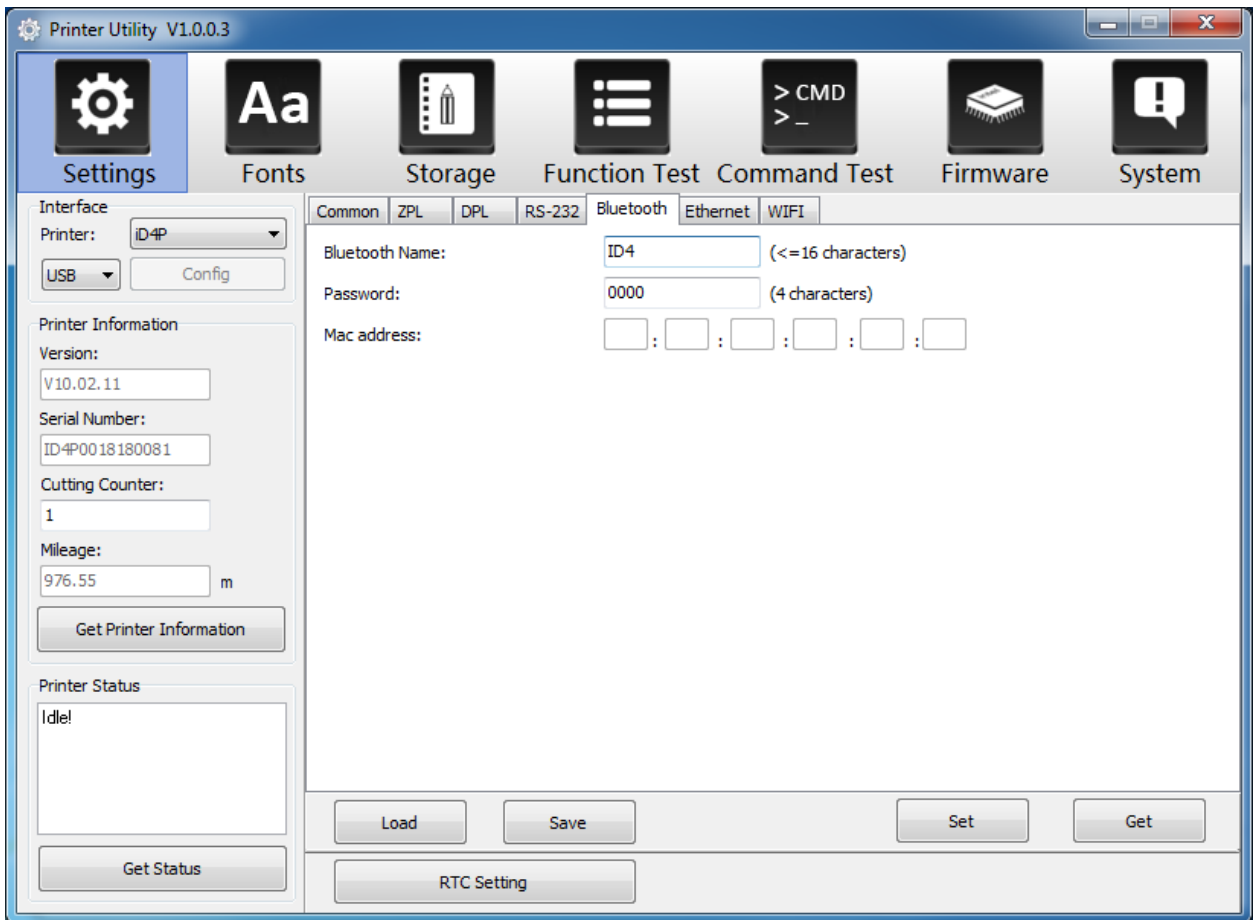

(7) Click “Ethernet”, then click “Get” to gain the relevant values.

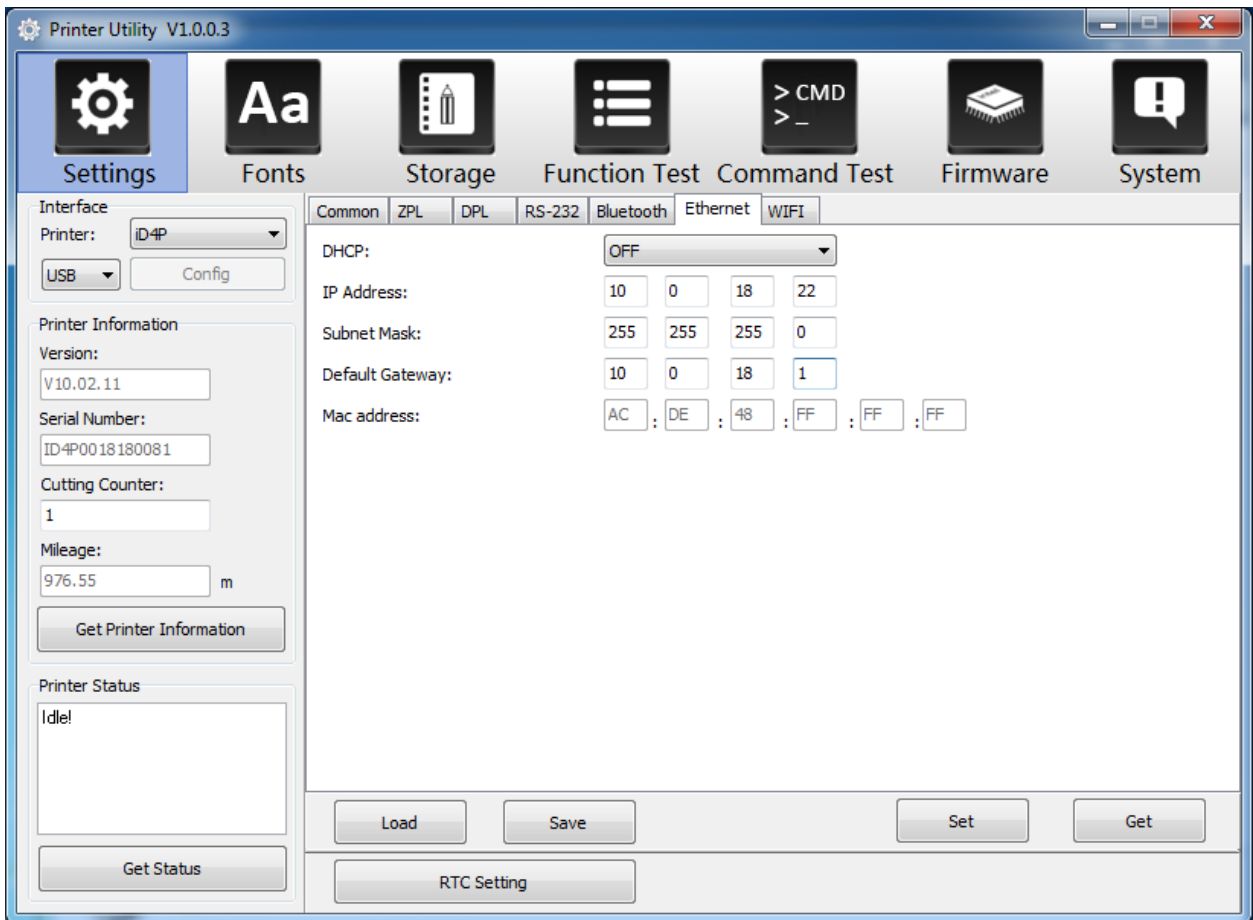

(8) Click “WIFI”, then set up the name, password and so on.

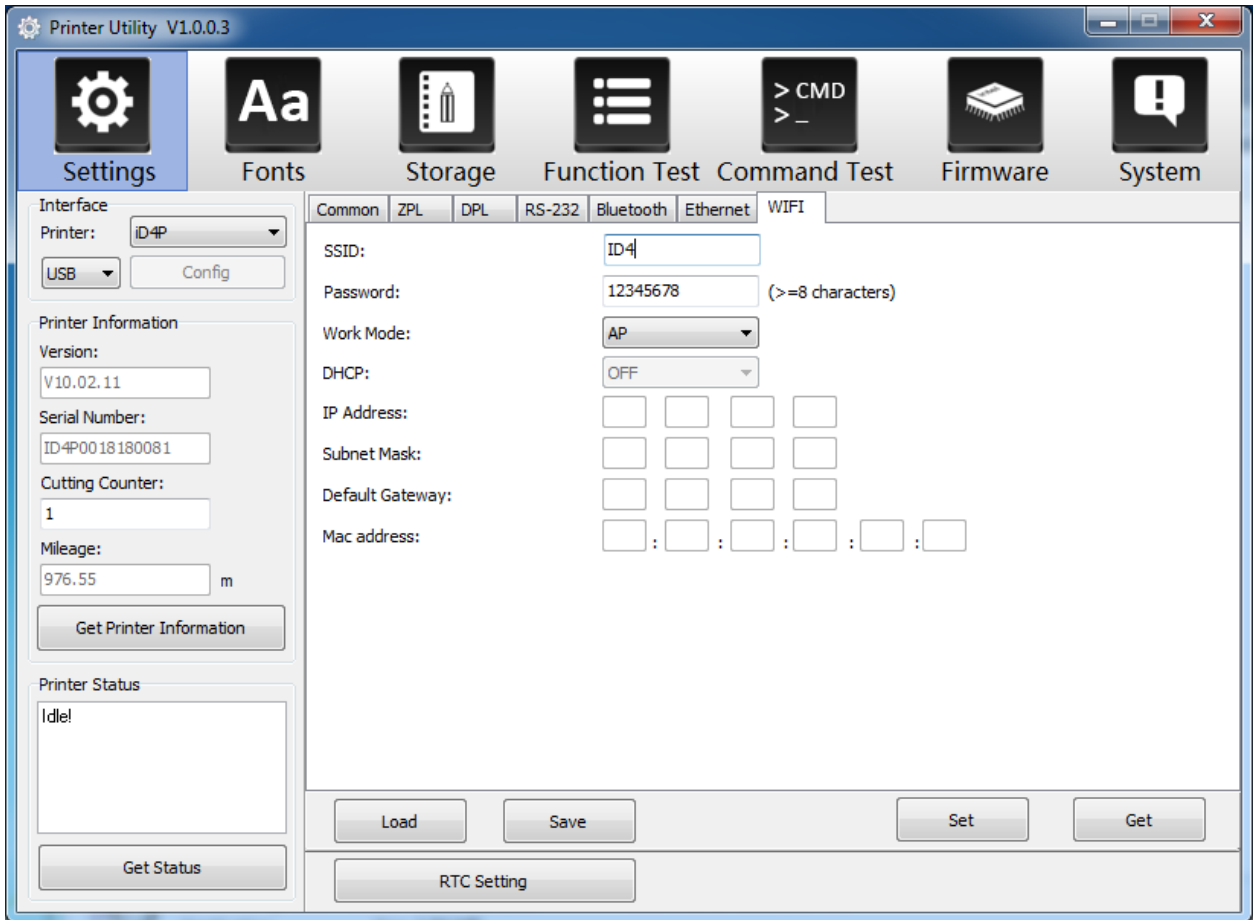

(9) Click “RTC Setting”. Click “Get System Date Time” to get the values, and click “Setup” to save them. Then click “Close”, and back to the main menu.

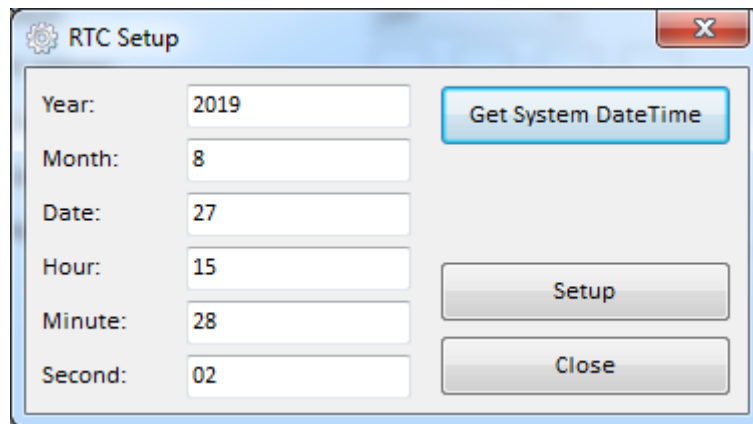

**Note:**

- ① Finishing all the settings, user can click “Set” to save the values changed.
- ② Click “Get”, and user will get the default values.

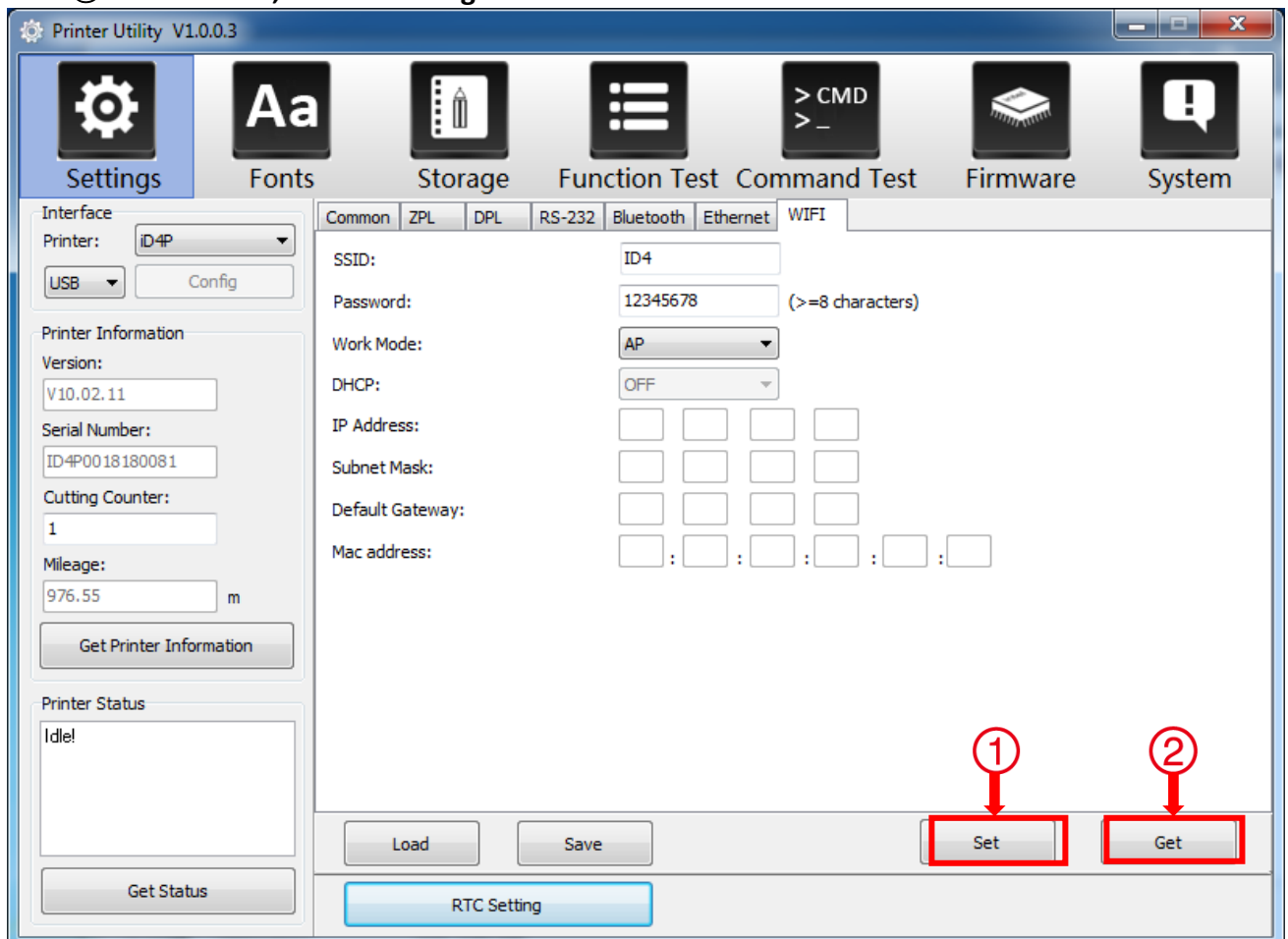

3. Click "Storage" to print image.

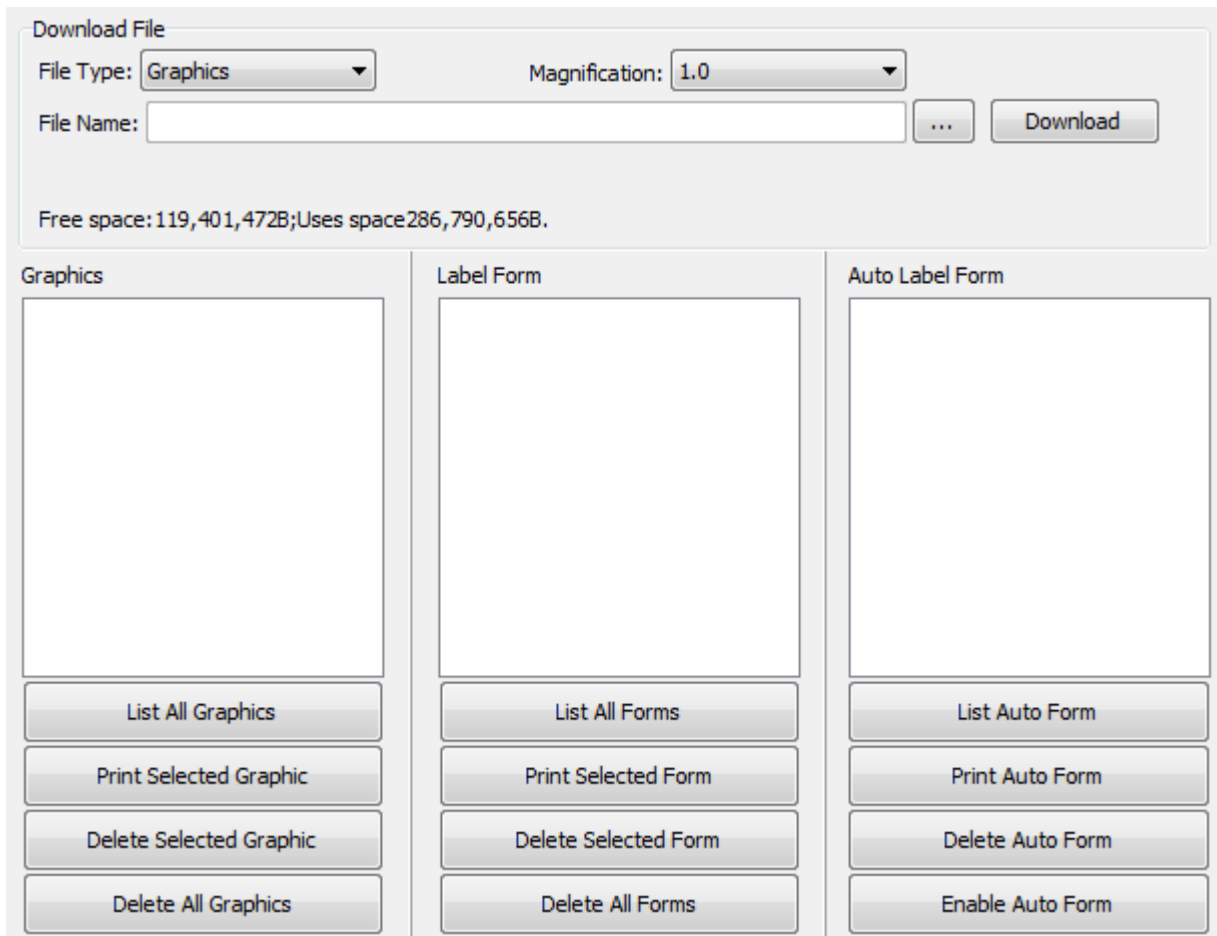

(1) Click "File name" to select the image.

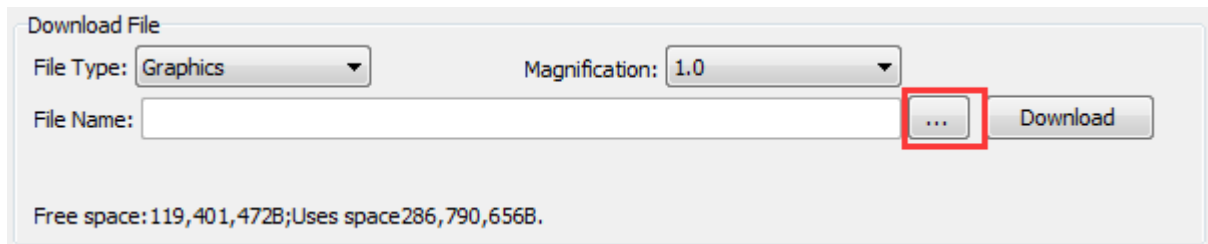

**Note:** The file name must be in English or number, and the filename length must be less than 32.

(2) Click “Download”.

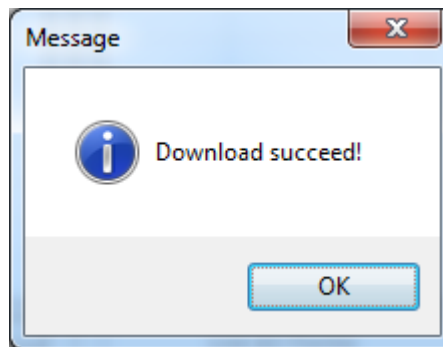

(3) Select the downloaded graphic, and then click “print selected graphic” to print the picture.

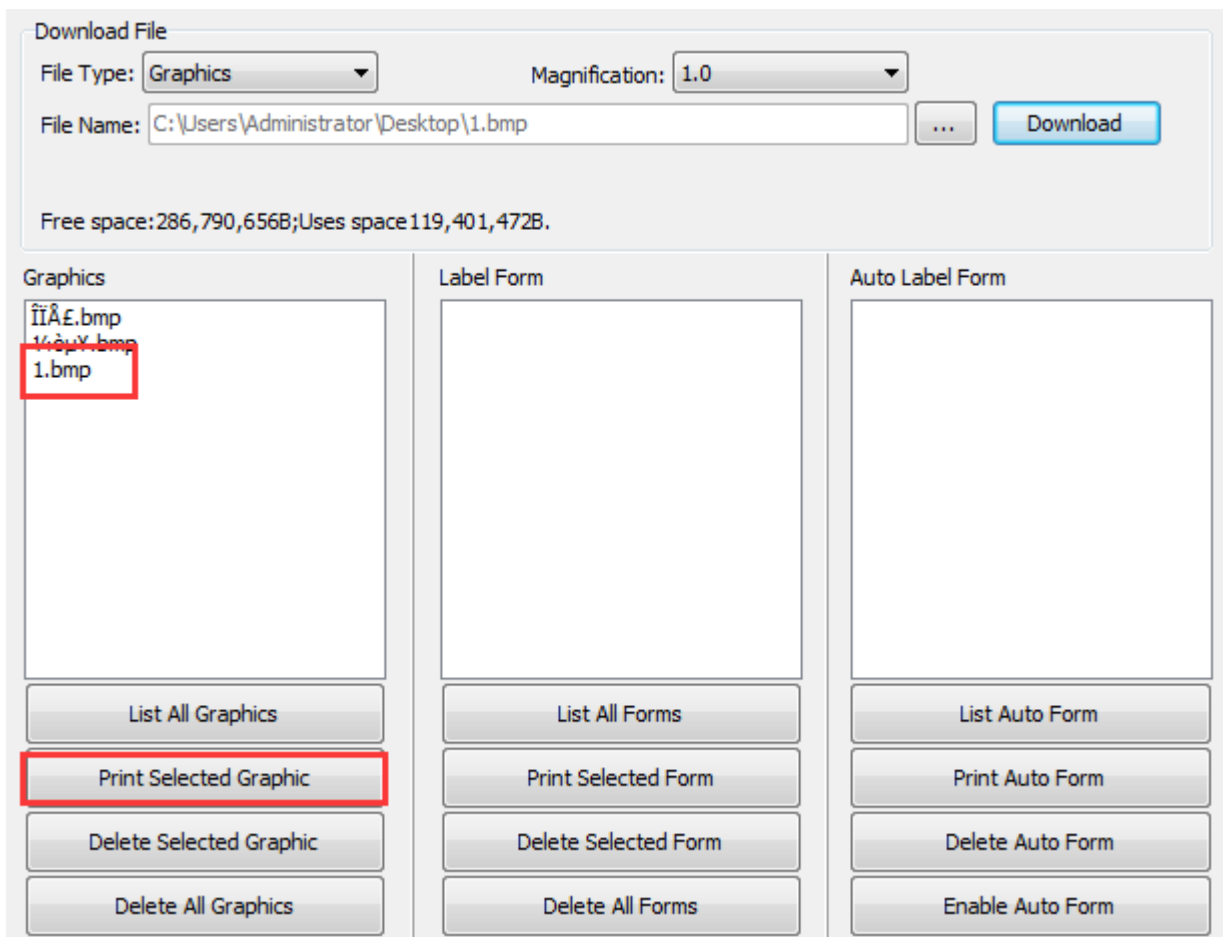

(4) You can set a magnification of the graphic as needed.

The screenshot displays the 'Download File' section of the software interface. At the top, there is a 'File Type' dropdown menu set to 'Graphics' and a 'Magnification' dropdown menu currently showing '1.0'. The 'Magnification' dropdown is open, showing a list of options: 1.0, 1.5, 2.0, 2.5, and 3.0. The '2.5' option is highlighted. Below the dropdowns, the 'File Name' field contains the path 'C:\Users\Administrator\Desktop\1.bmp'. To the right of the file name field are three buttons: an ellipsis (...), a 'Download' button, and another button. Below the file name field, the text 'Free space: 286,790,656B; Uses space 119,401,472B.' is displayed. The interface is divided into three columns: 'Graphics', 'Label Form', and 'Auto Label Form'. Each column contains a list of files or forms and a set of action buttons. The 'Graphics' column lists three files: 'ÏÏÅ£.bmp', '¼ôµ¥.bmp', and '1.bmp'. The 'Label Form' and 'Auto Label Form' columns are currently empty. The action buttons for each column are: 'List All Graphics', 'Print Selected Graphic', 'Delete Selected Graphic', and 'Delete All Graphics' for the Graphics column; 'List All Forms', 'Print Selected Form', 'Delete Selected Form', and 'Delete All Forms' for the Label Form column; and 'List Auto Form', 'Print Auto Form', 'Delete Auto Form', and 'Enable Auto Form' for the Auto Label Form column.

Graphics	Label Form	Auto Label Form
ÏÏÅ£.bmp ¼ôµ¥.bmp 1.bmp		
List All Graphics	List All Forms	List Auto Form
Print Selected Graphic	Print Selected Form	Print Auto Form
Delete Selected Graphic	Delete Selected Form	Delete Auto Form
Delete All Graphics	Delete All Forms	Enable Auto Form

4. Click "Download Vector fonts".

(1) Click "Select Font" to select the vector font you want.

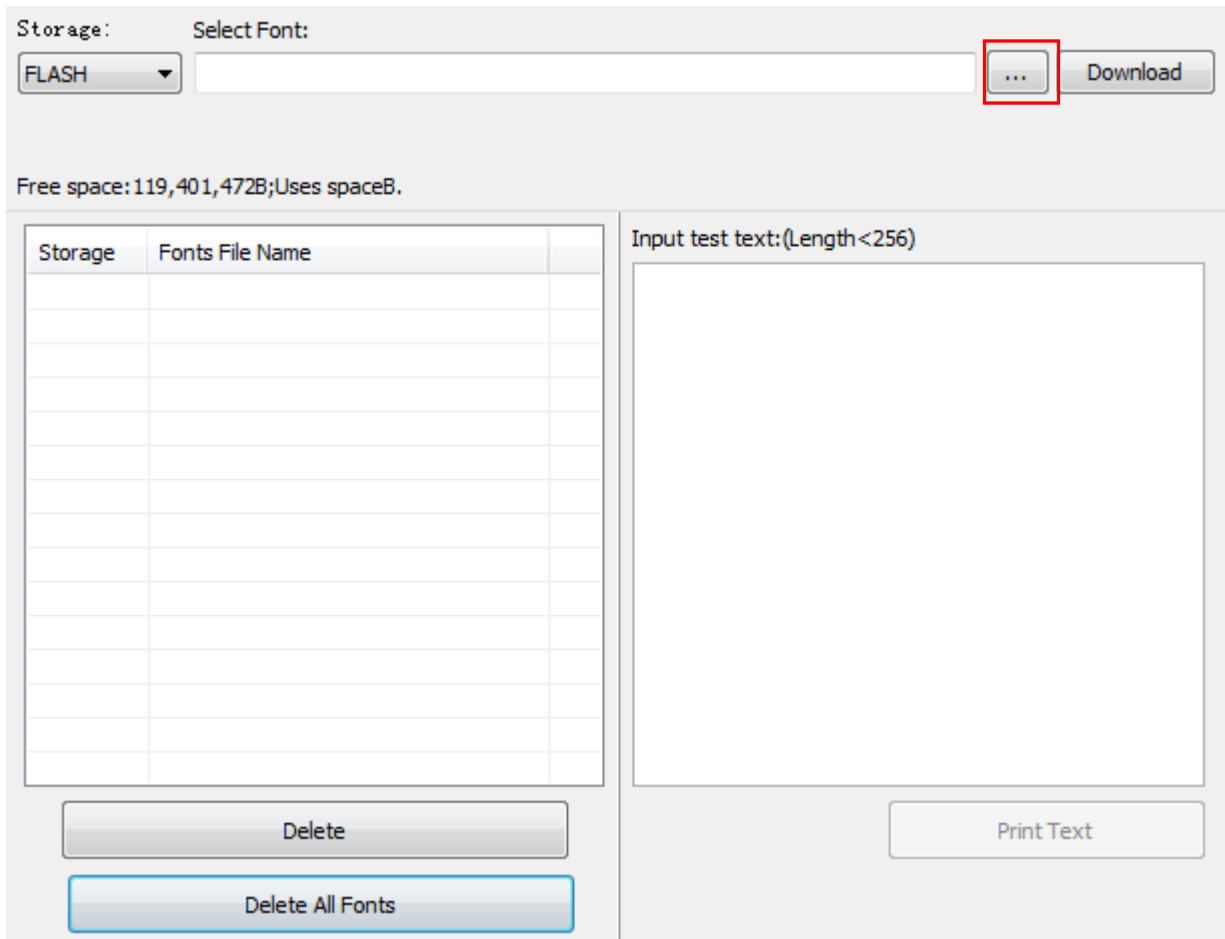

(2) Click "Download" (Note: The font file name must be in English or number).

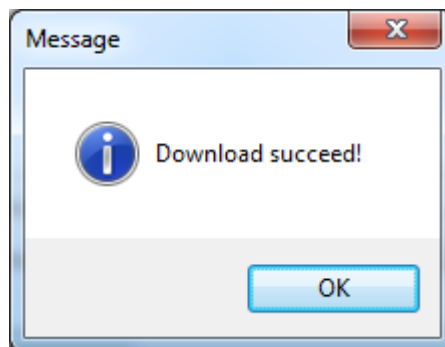
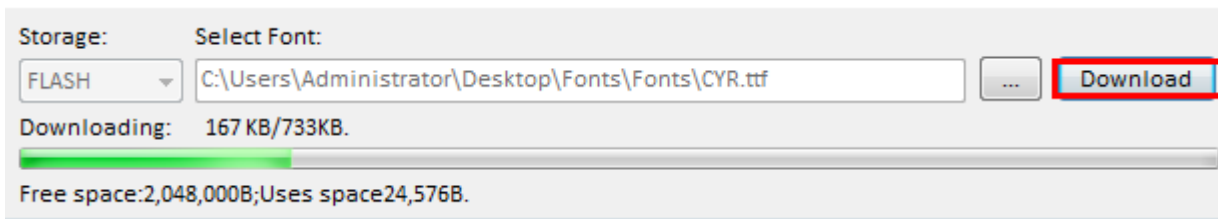

(3) Select the downloaded font file, enter the print content in the text box, and click “Print Text”.

Storage: FLASH Select Font: C:\Users\Administrator\Desktop\Fonts\Fonts\cour.ttf ... Download

Downloading: 788 KB/788KB.

Free space:1,069,056B;Uses space1,003,520B.

Storage	Fonts File Name
FLASH	COUR.TTF
FLASH	CYR.TTF

Input test text:(Length<256)  
abc123

Printable Width: 30 (10-108)mm  
Printable Height: 30 (10-210)mm

Delete  
Delete All Fonts  
Print Text

5. Click "Function Test". User can carry the followings such as sensor calibration, pattern print testing and so on.

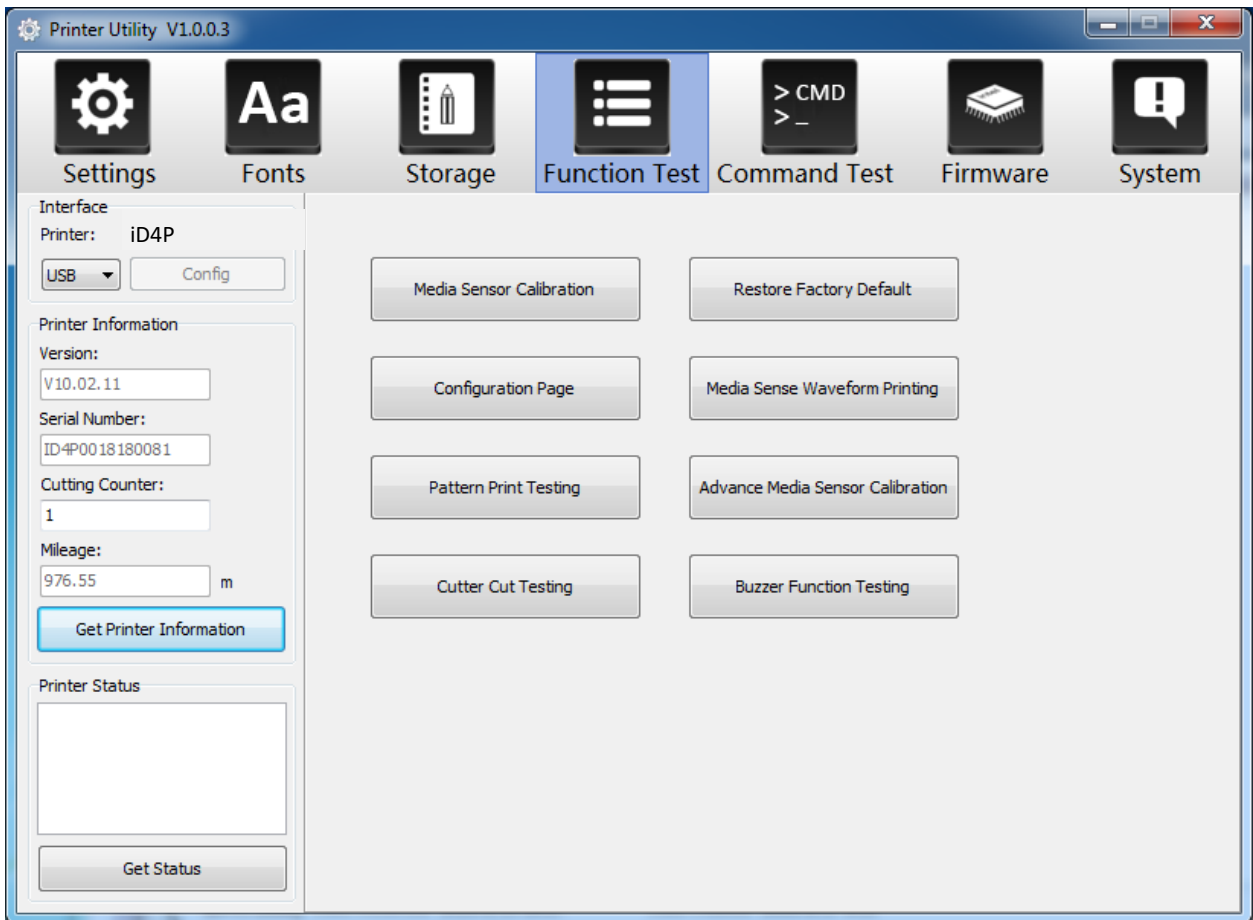

6. Click "System". Click "language" and choose the language of printer utility.

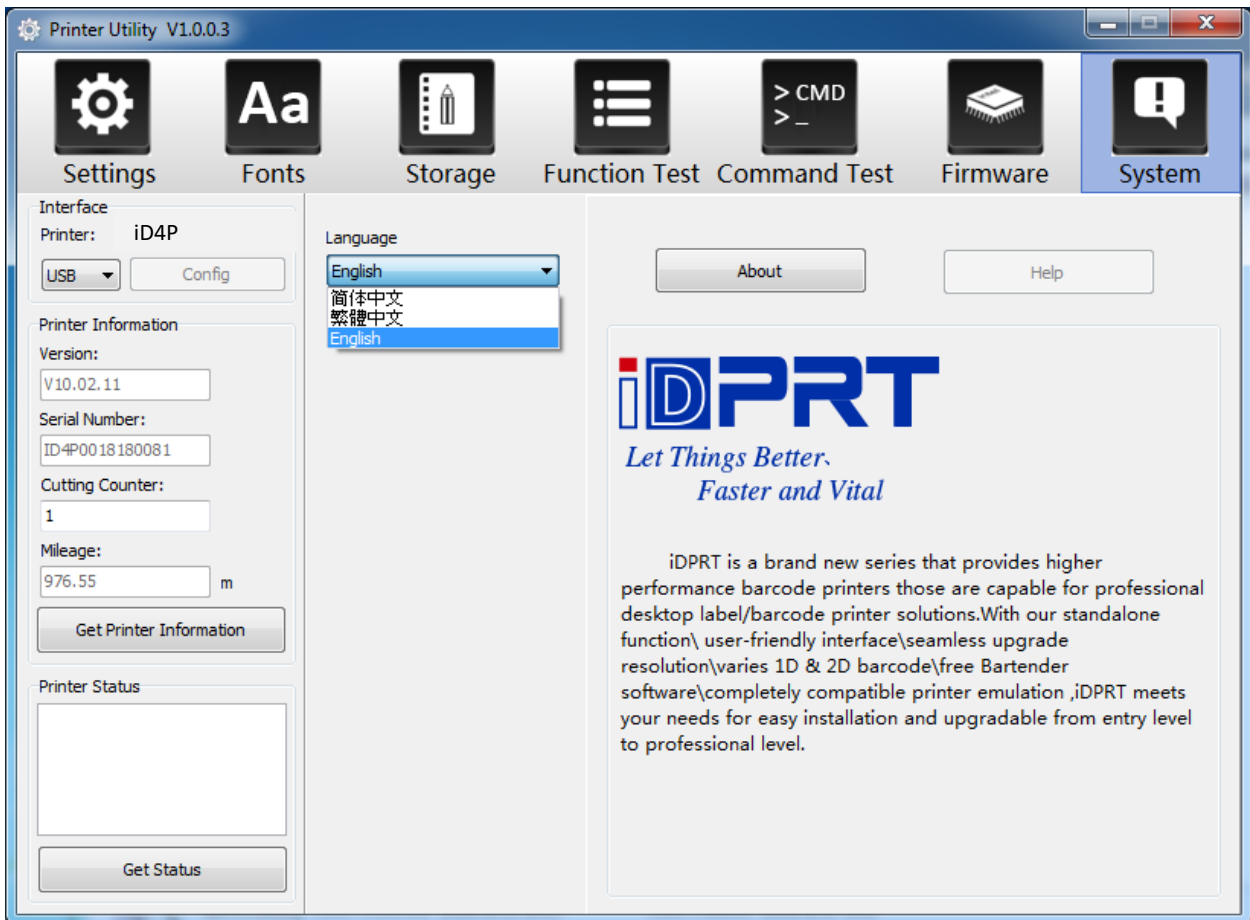

## **Chapter 7 Seagull Windows Driver Instructions**

### **7.1 Introduction**

The following operating systems are supported:

- Windows Vista, Windows 7, Windows 8 and 8.1, and Windows 10.
- Windows Server 2008, 2008 R2, 2012, 2012 R2, and 2016.
- 32-bit and 64-bit (x64) editions.

### **7.2 Installation Preparation**

Download Seagull Windows Driver application program in CD.

## 7.3 Installation



Note:

- Under different operating systems, the screen may be slightly different. Take Windows 7 as example.
- Take printer iD4P as example. Please refer to printer iD4P when using printer iD4S.
- To avoid the prevention, recommend to close the security software before installation.

1. Select one interface to connect your printer to computer.
2. Turn on the printer and check if it is connected to computer successfully.
3. Double click Seagull Windows Driver .
4. Read and agree the license agreement. Then click "Next".

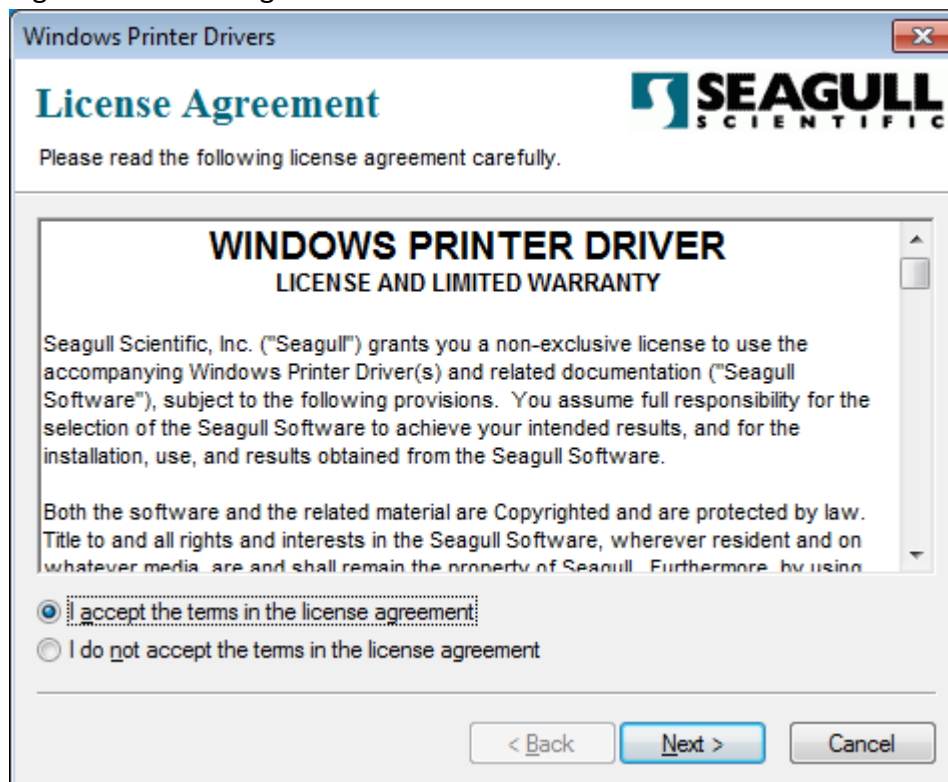

5. Choose the installation directory, then click "Next".

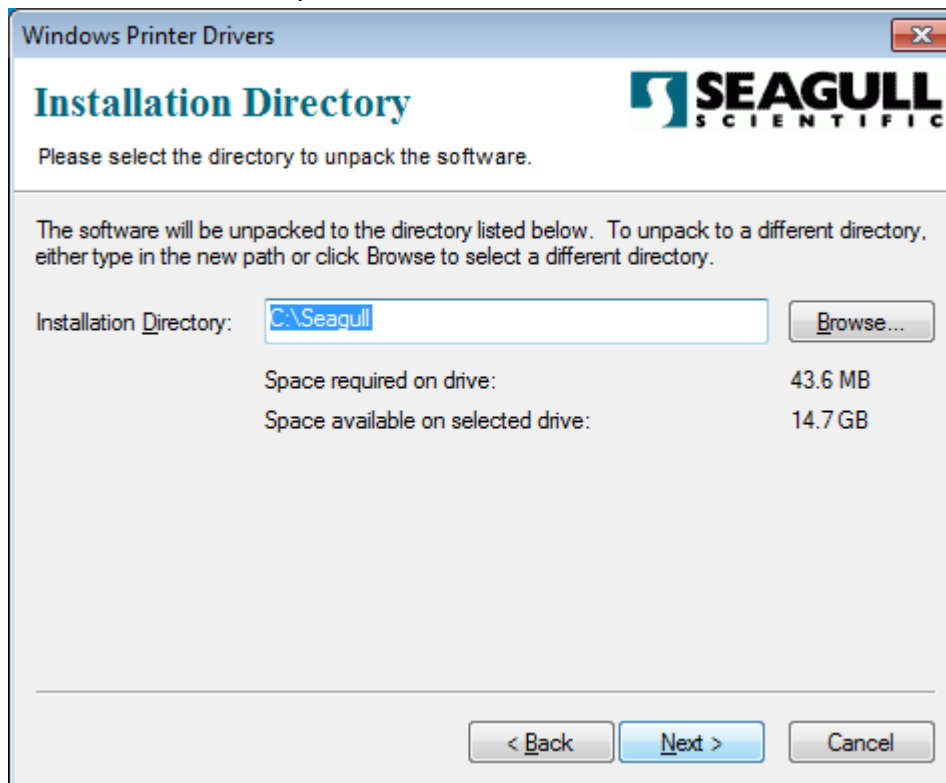

6. Click "Finish".

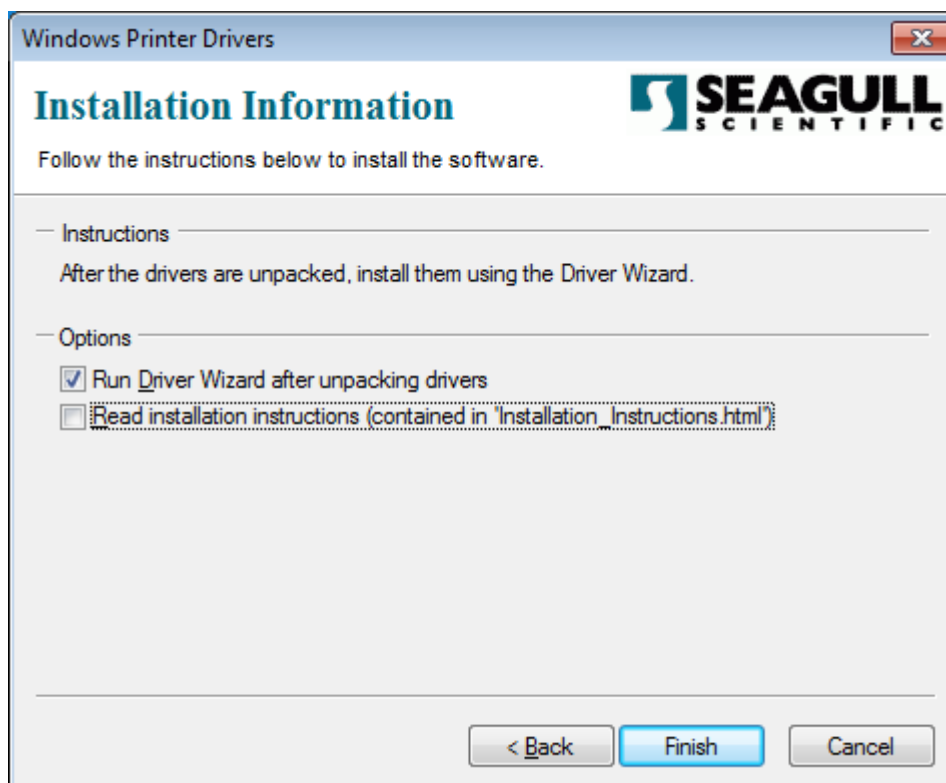

7. Choose "Install printer drivers" , then click "Next".



**Note:** If you have connected the printer to computer, it will detect and install the driver automatically. (eg.: USB port)

8. Choose "Install a driver for a Plug and Play printer, then click "Next".

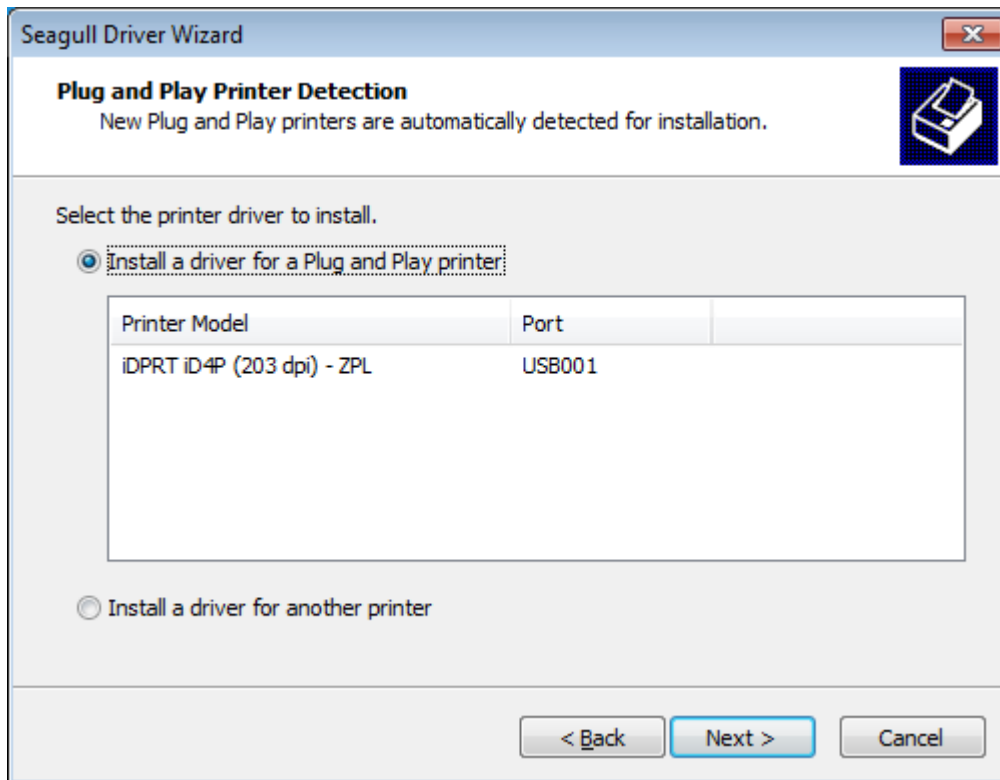

9. Enter a name for this printer, then click "Next".

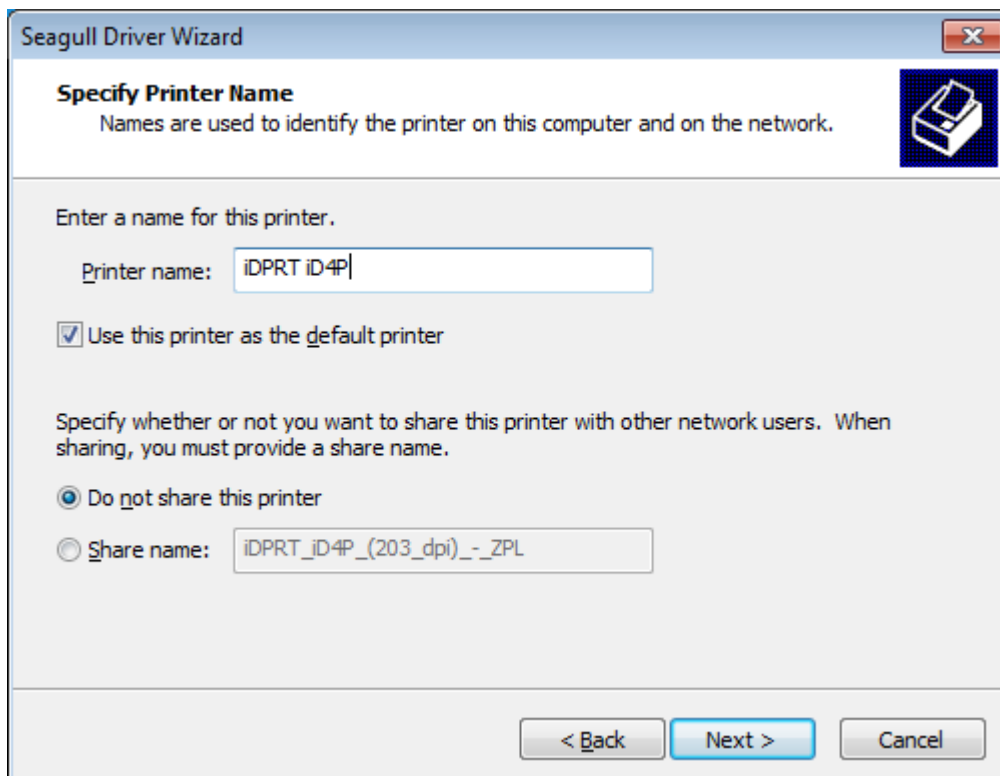

10. Click "Finish".

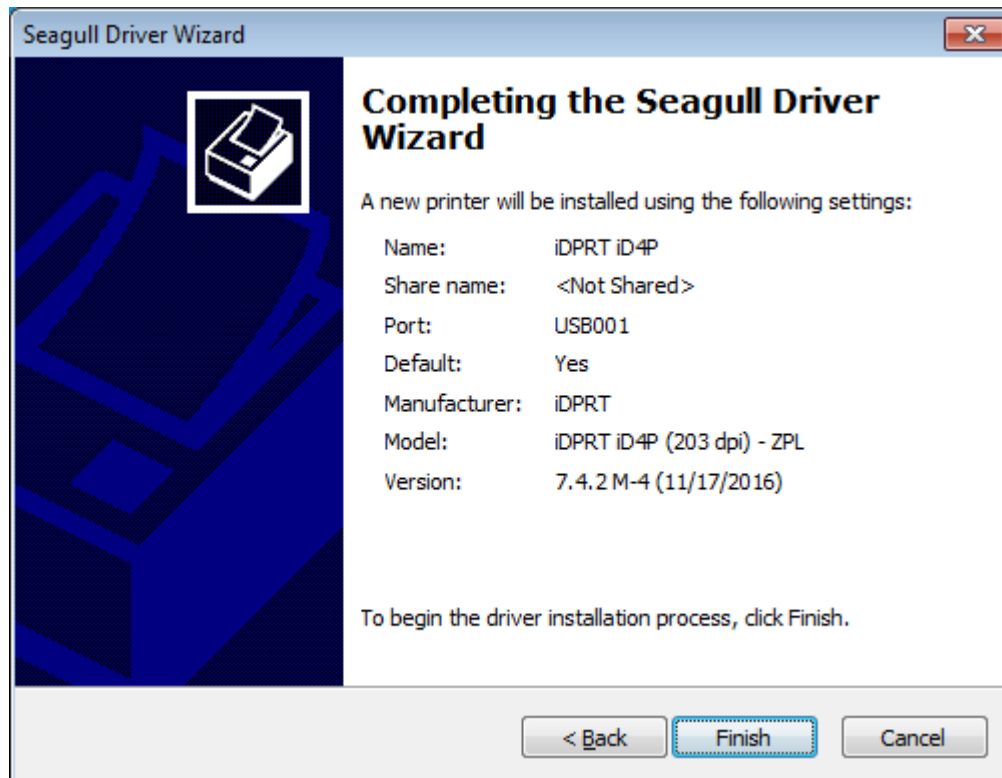

11. Click "Close", and the driver is installed successfully.

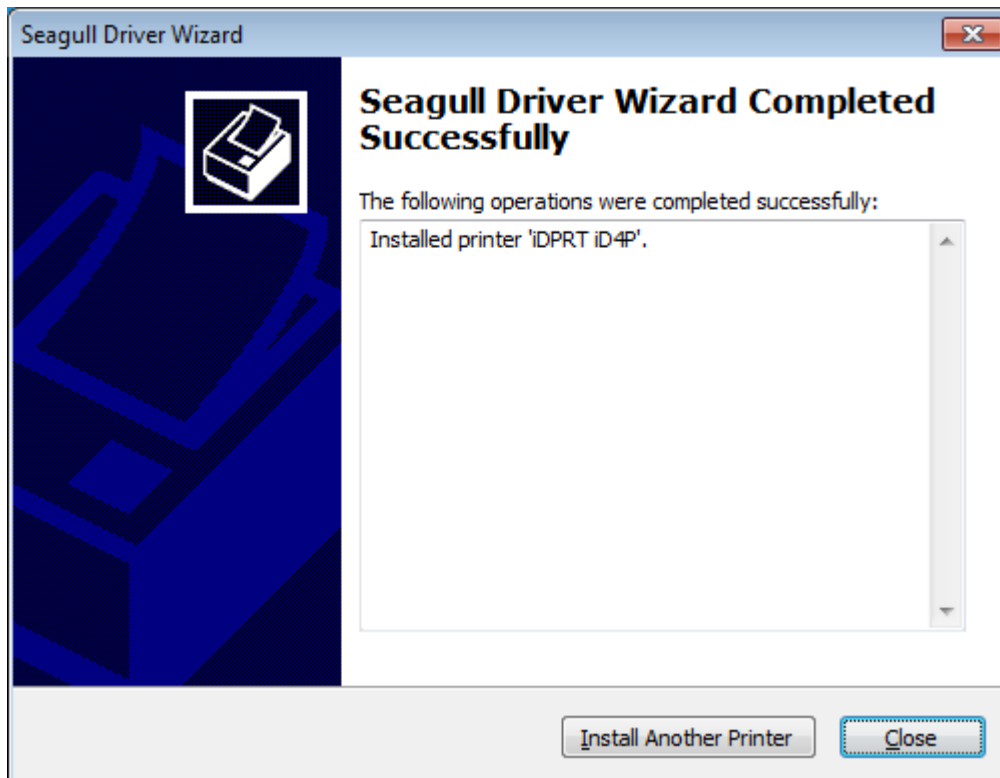

12. After installation, the icon will be found in "Start" → "Devices and Printers".



**Note:**

- If you have already installed the driver (No matter what kind of ports), it will generate a USB port automatically when connecting the printer to computer.
- Any problems exist, please use our utility tool in CD.

## 7.4 Usage

### 7.4.1 Printing Preferences

1. Click "Start" → "Devices and Printers". Right click icon and choose "Printing preferences".

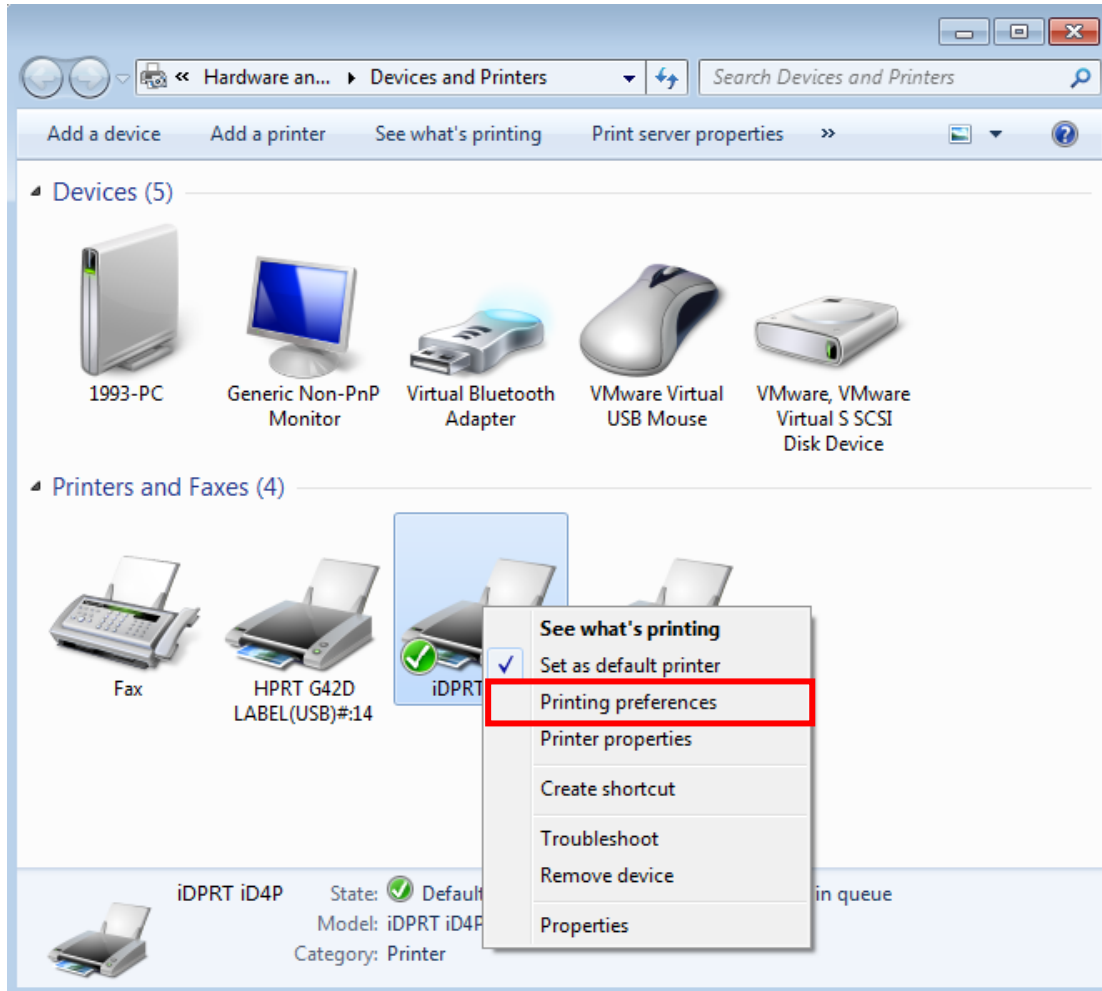

2. According to different needs, set up the page.

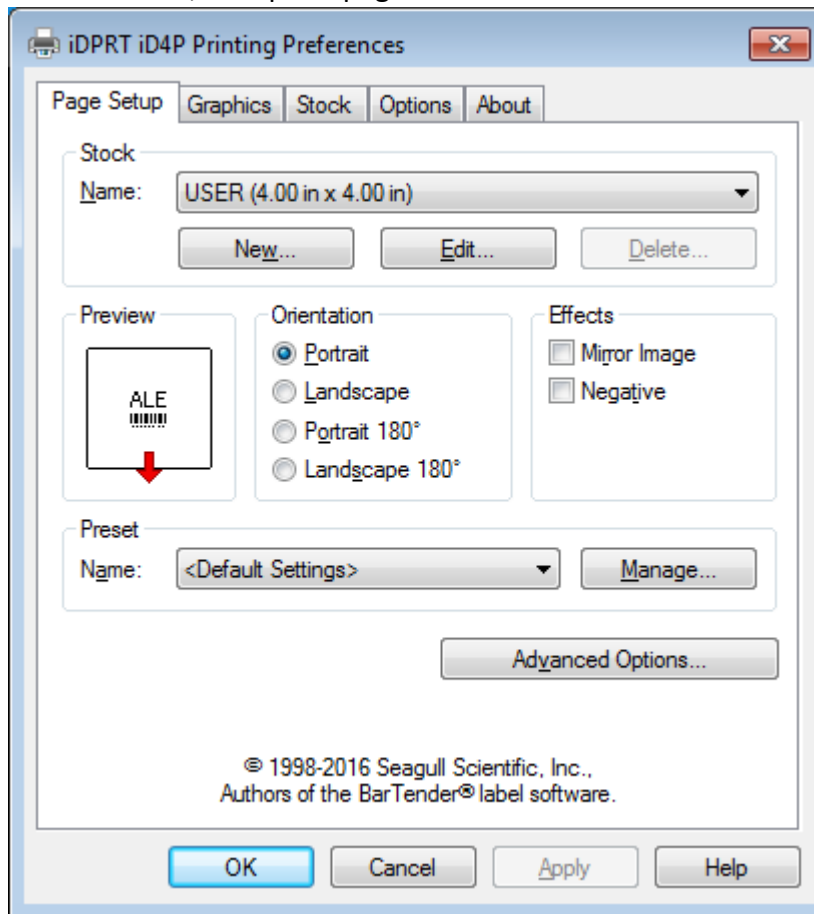

- Click “Stock”→“Name”, and choose the paper type.

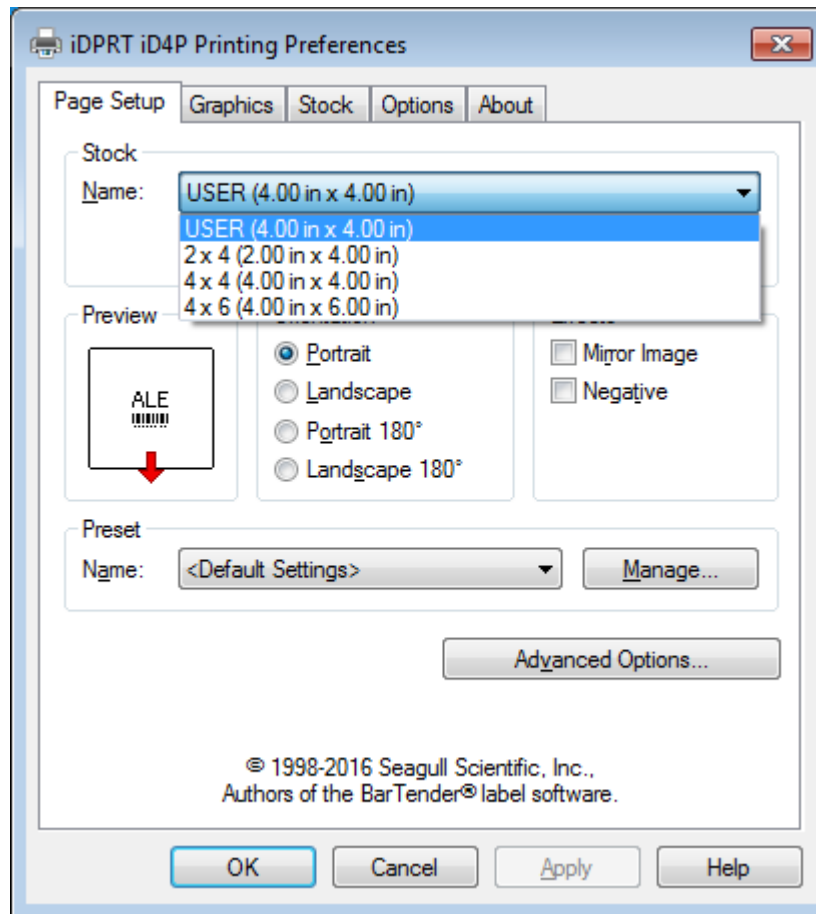

- Click “New Stock”, and set up a new stock.

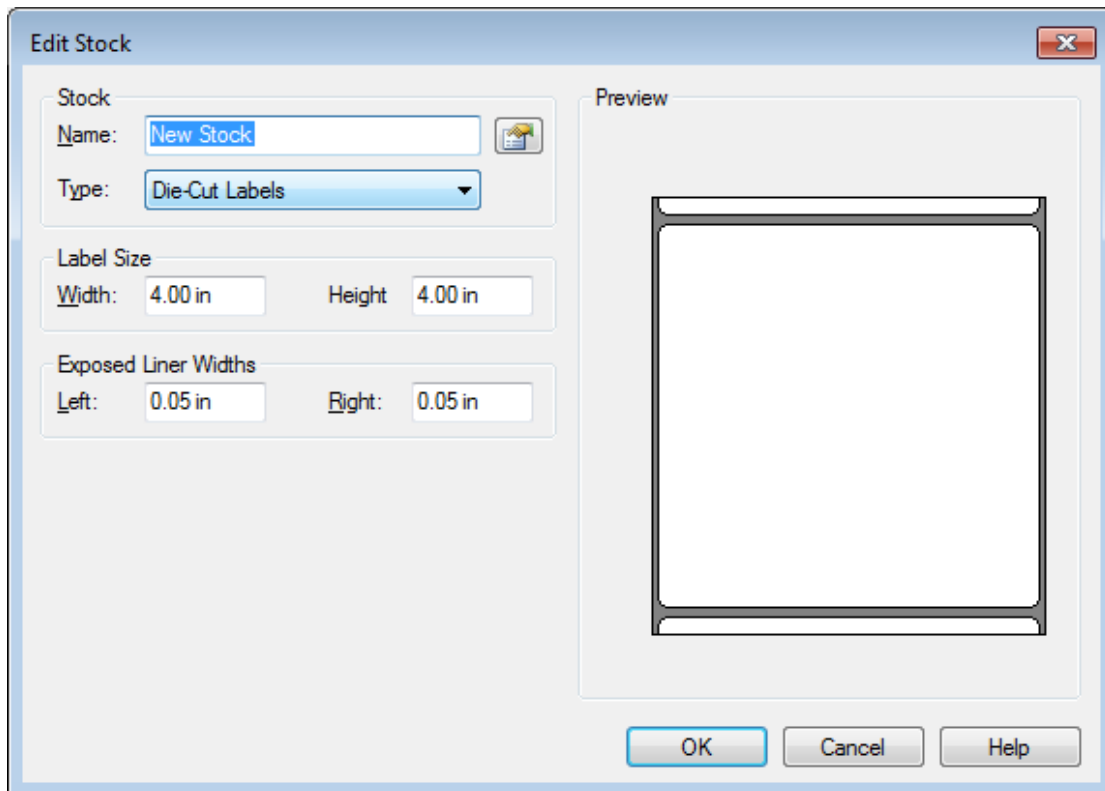

- Click “Edit Stock”, and edit the stock.

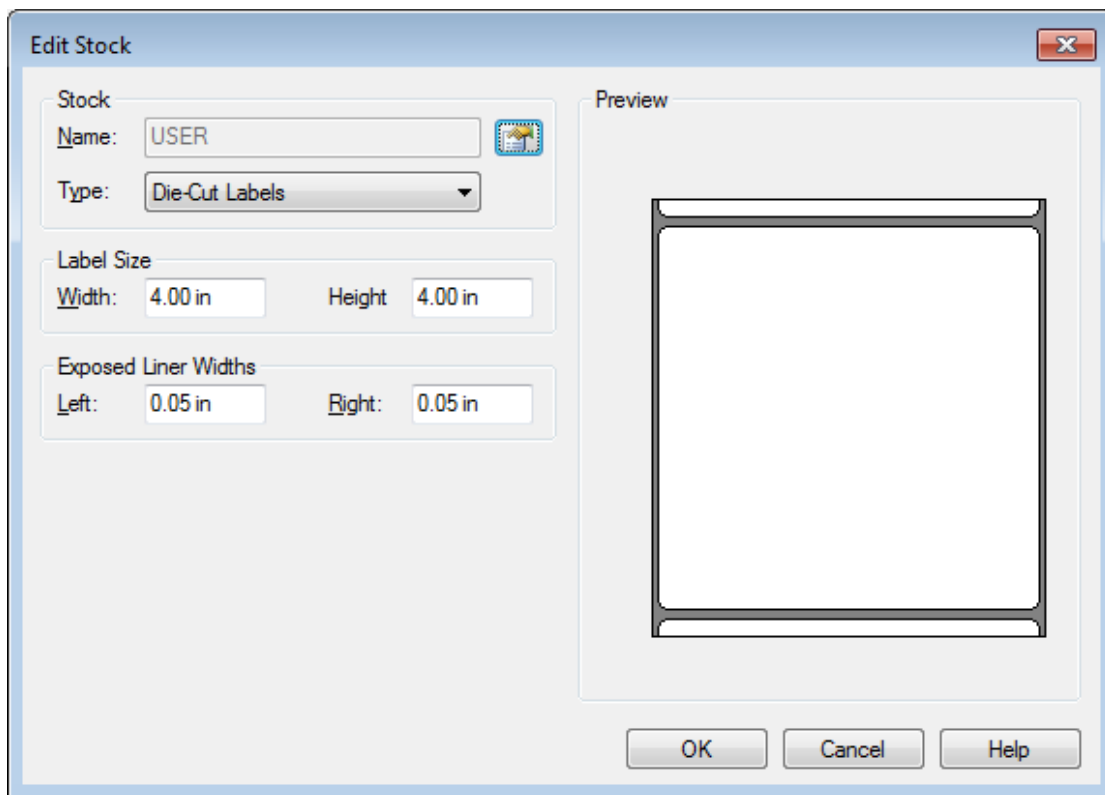

- Click “Delete Stock”, and delete the stock.

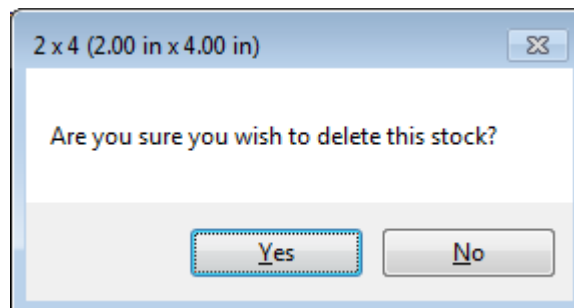

- Choose “Orientation” or “Effects”, showed in the “Preview”.

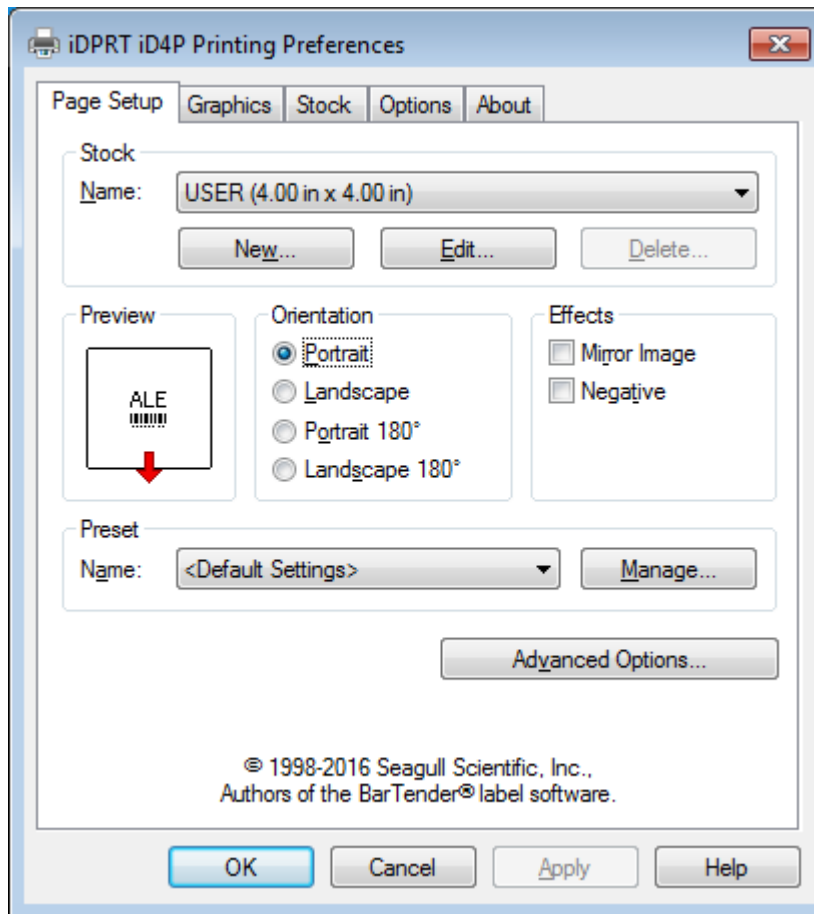

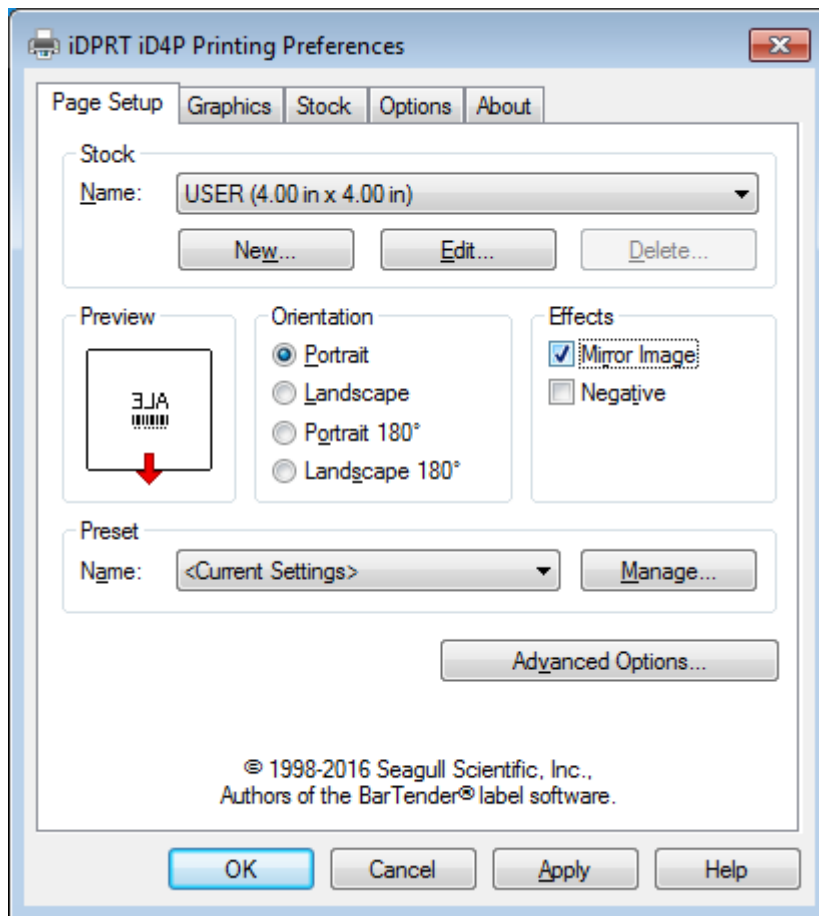

- Click “Preset” → “Name”, and back to the default settings.

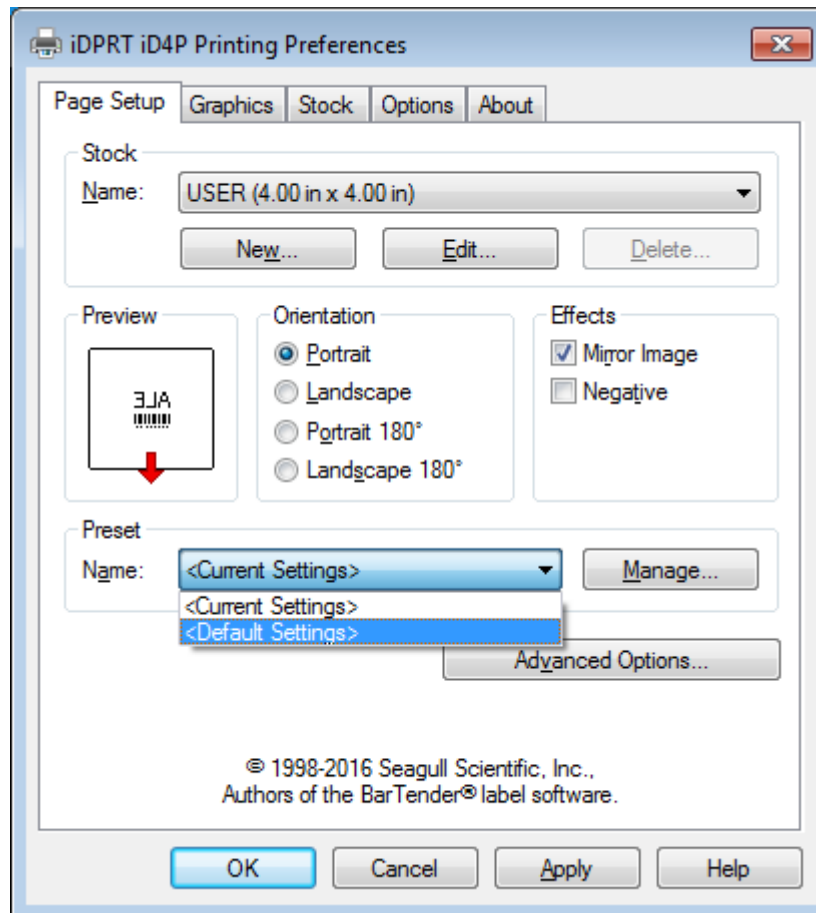

- Click “Manage”, and change the settings.

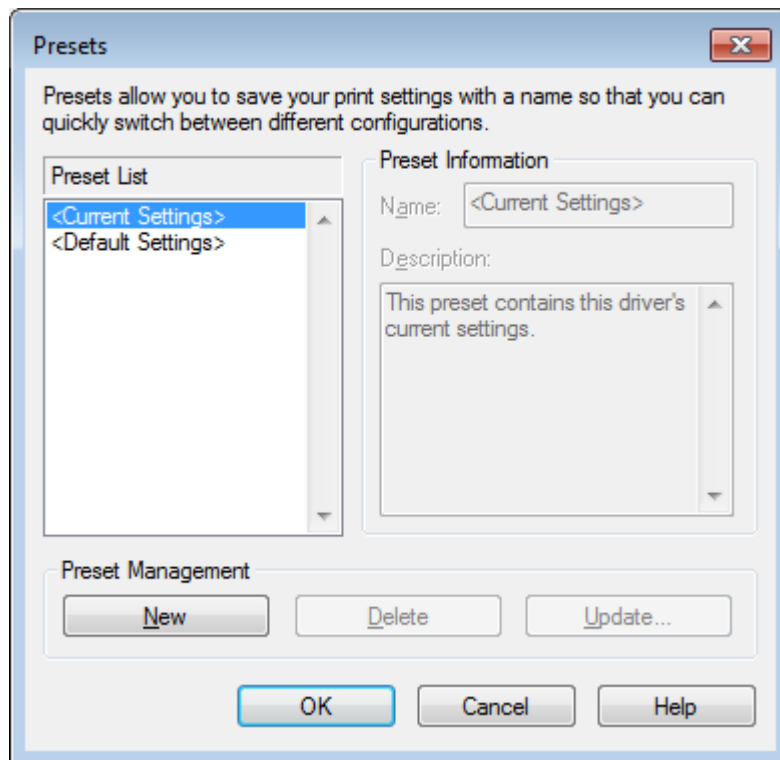

3. Click “Graphics”, and edit the pictures.

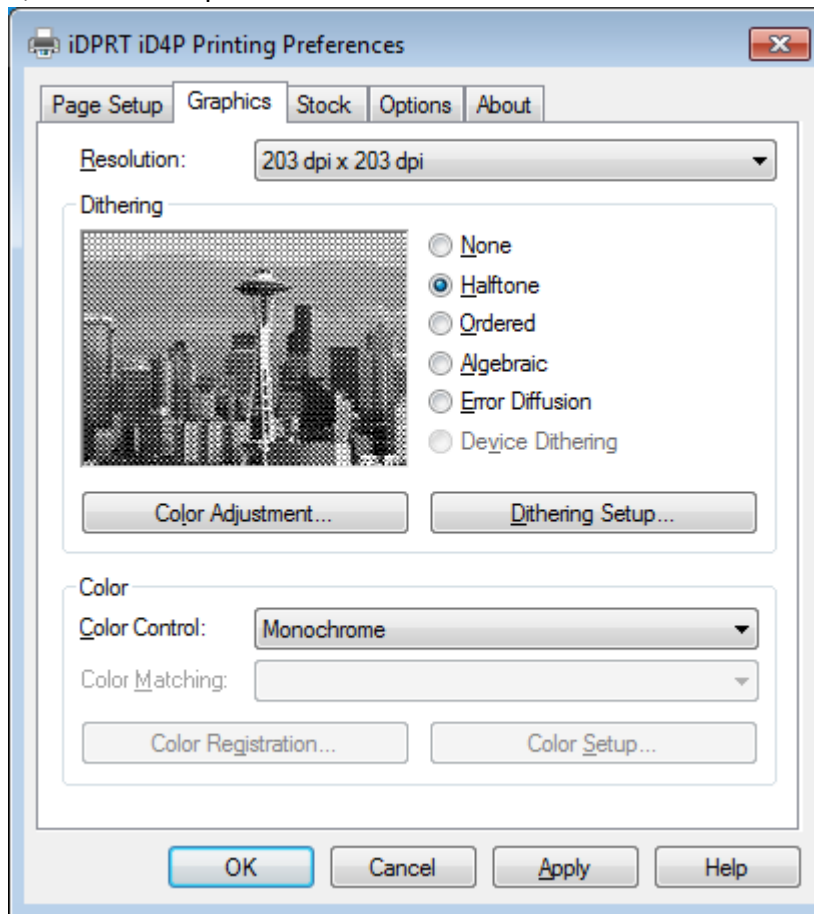

4. Click "Stock".

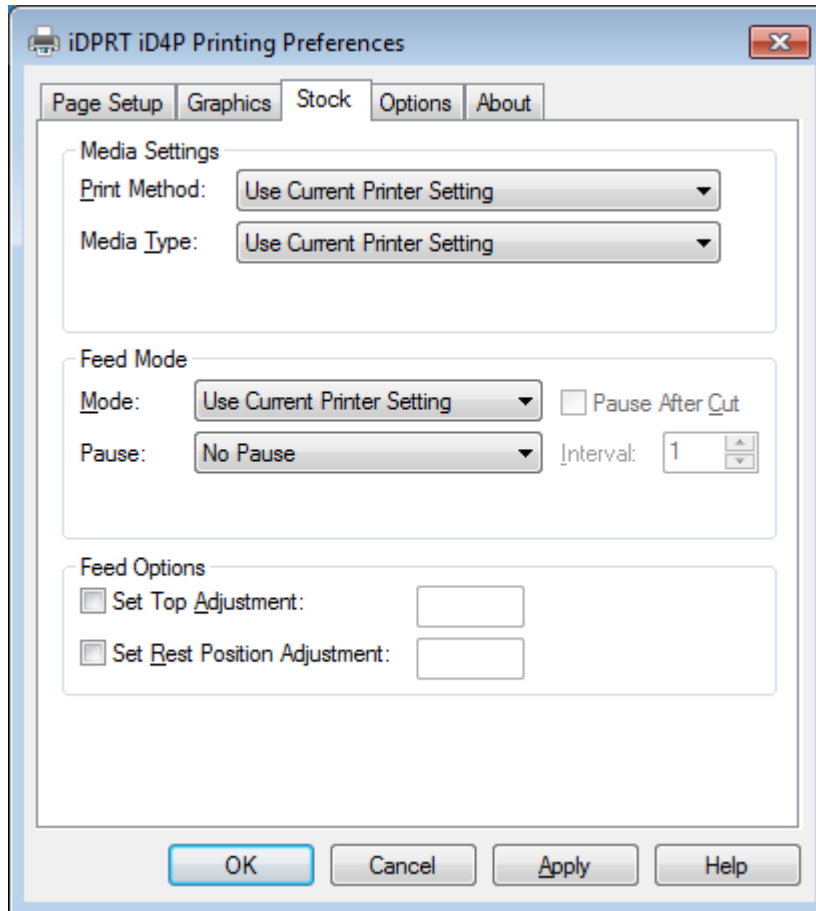

- Set up the print method.

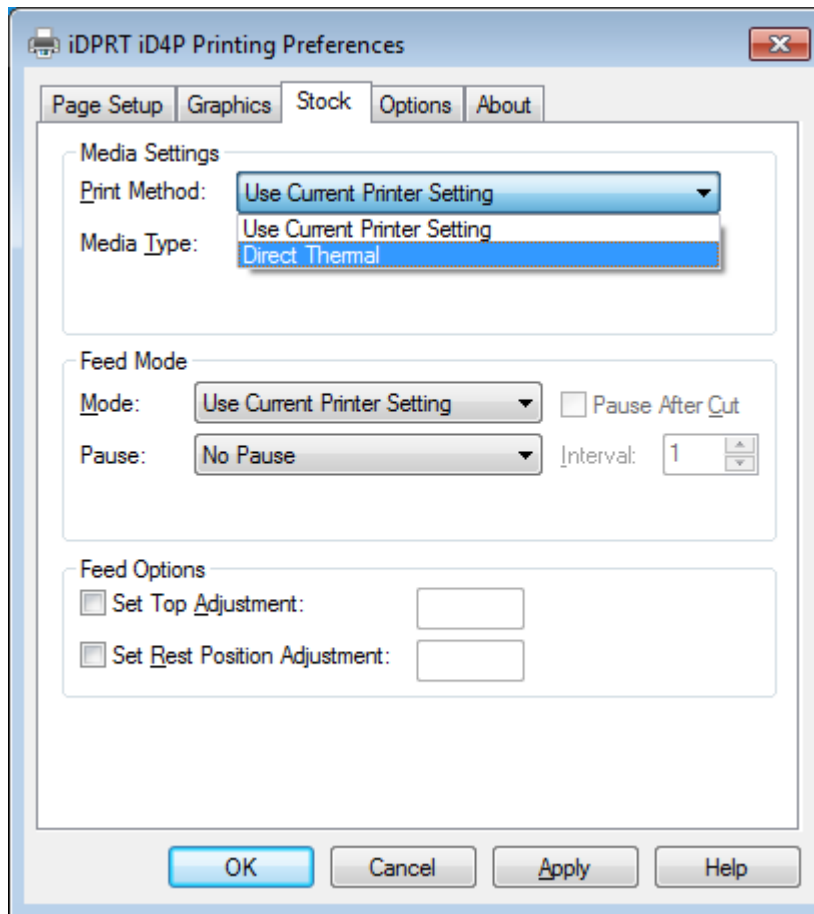

- Set up the media type.

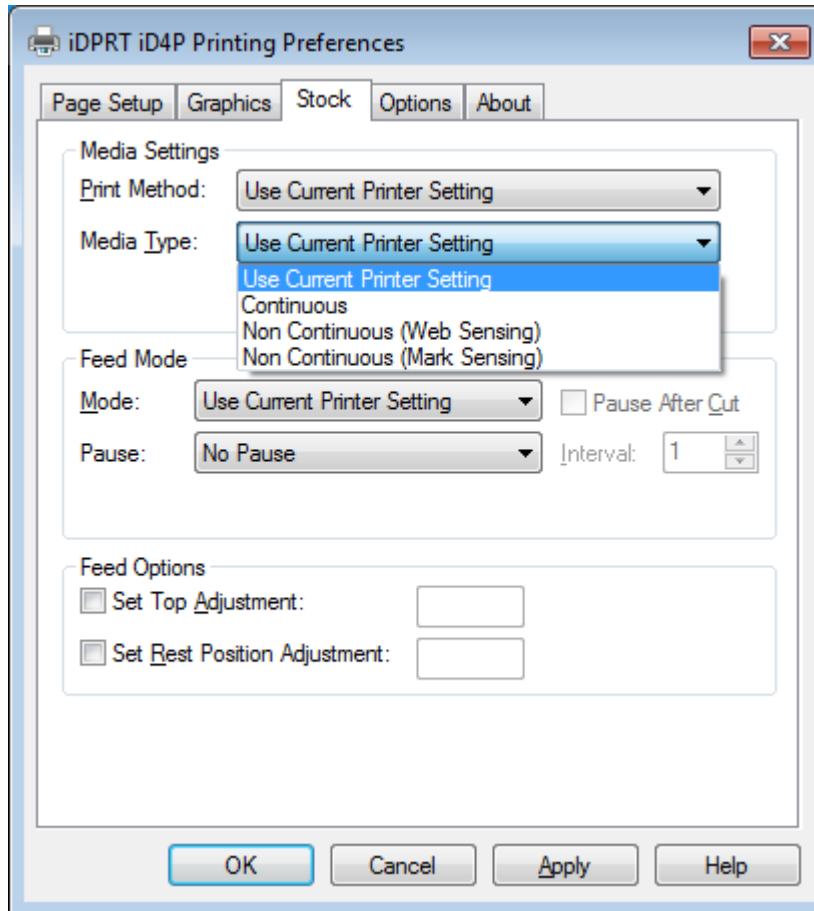

- Click “Feed Mode”→“Mode”, and choose the method of media handing.

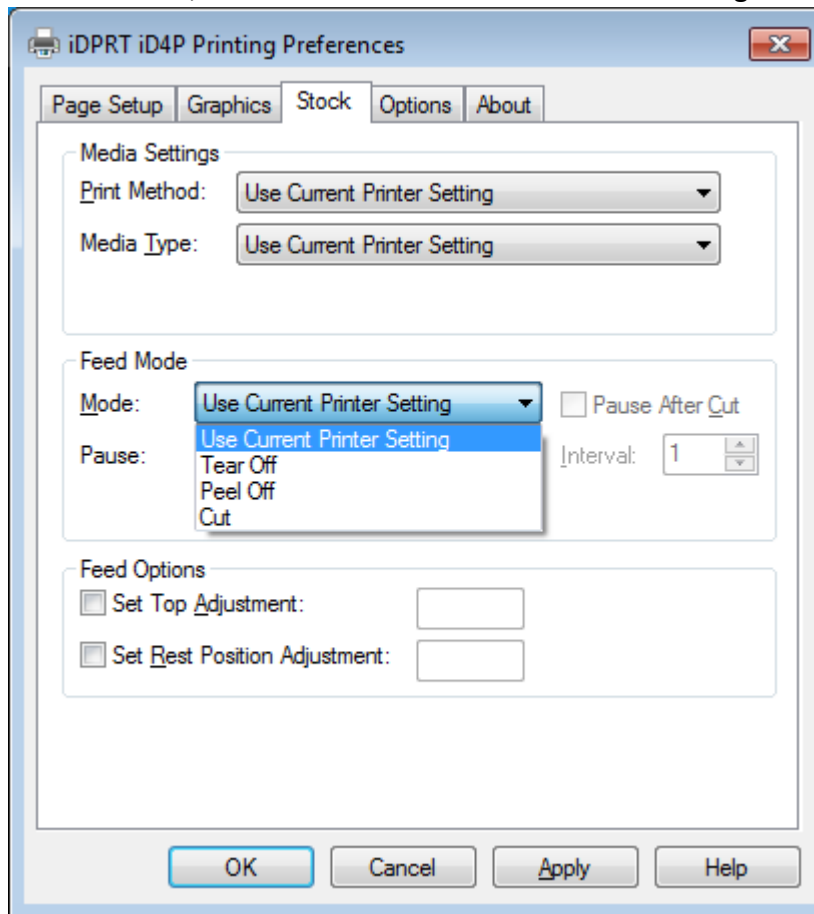

## 7.4.2 Printer Properties

1. Click “Start” → “Devices and Printers”. Right click the icon and choose “Printer properties”.

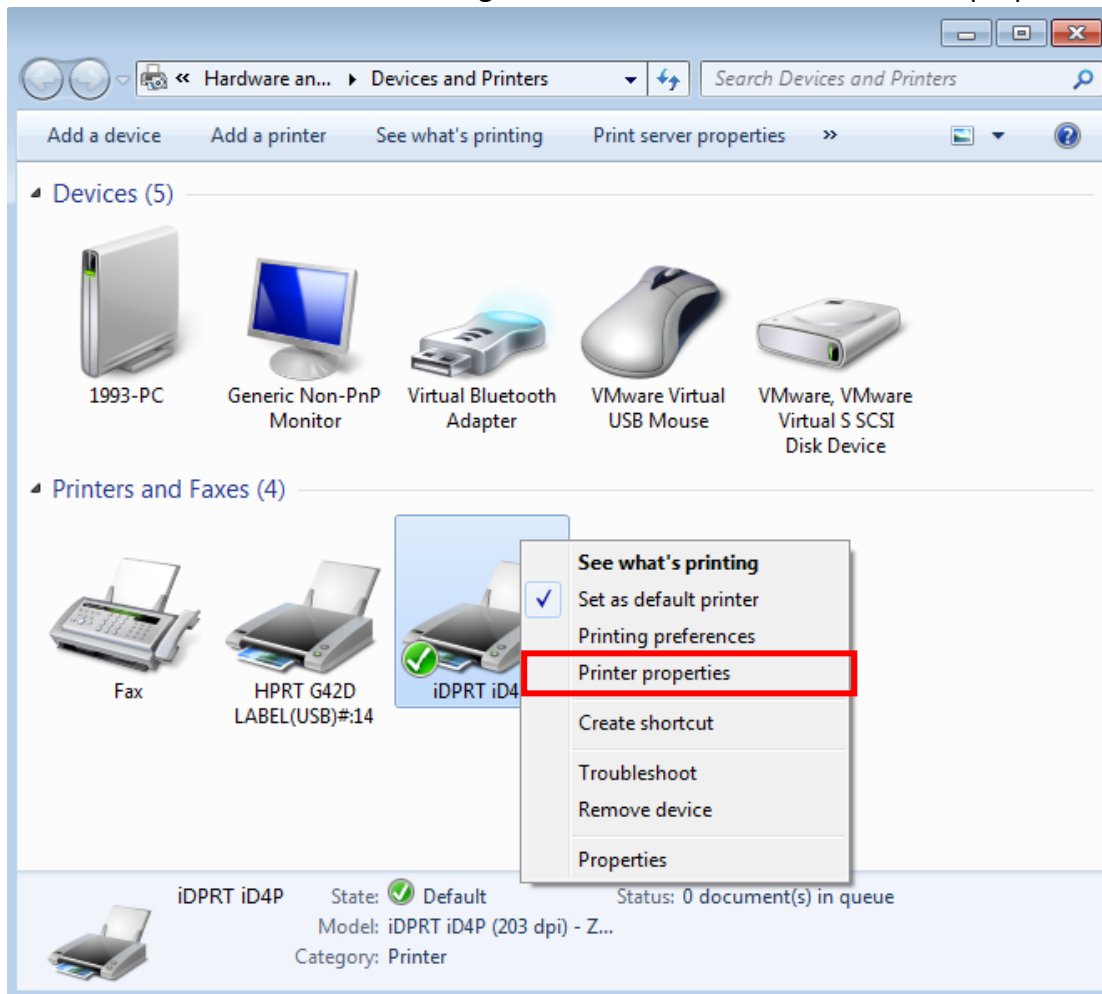

2. Click “General” → “Print Test Page”, and printer will print labels with current settings.

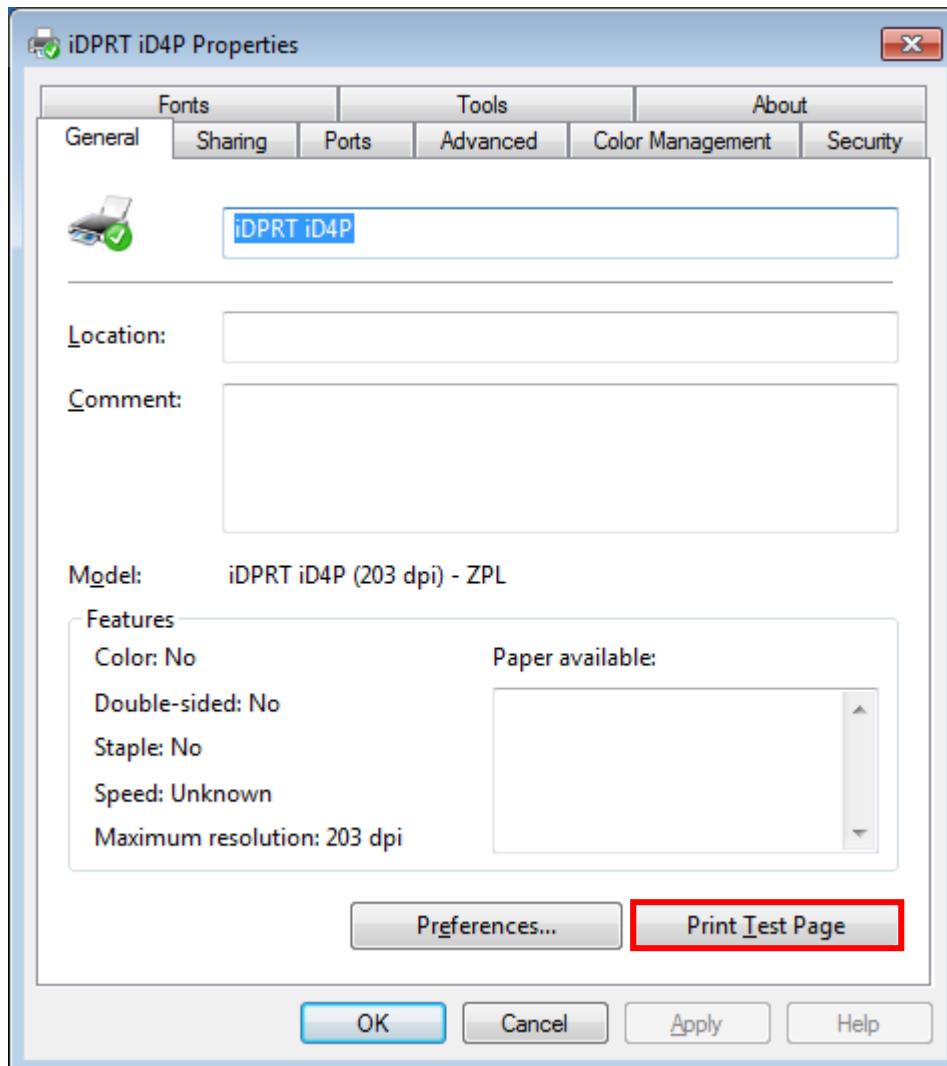

3. Click "Ports", and choose the port needed.

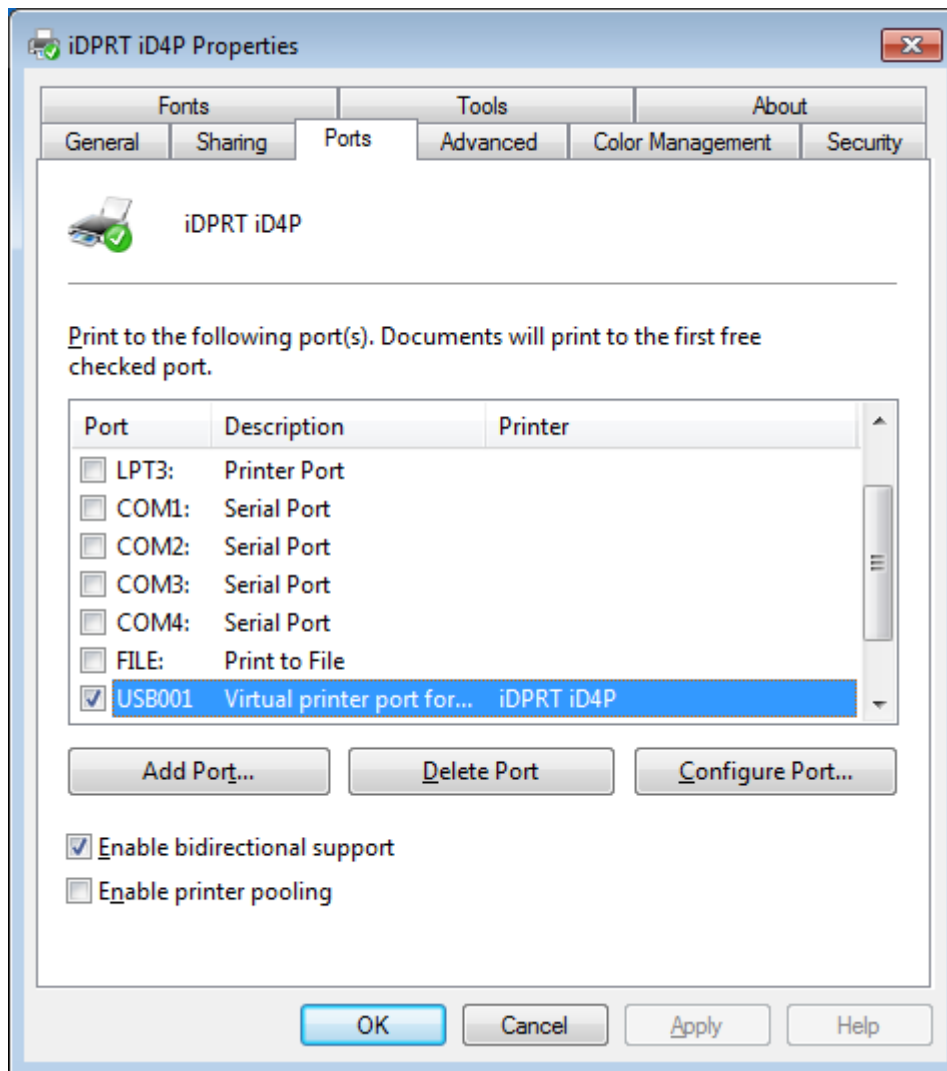

## **Chapter 8 BarTender Ultralite Instructions**

### **8.1 Introduction**

This chapter provides instructions on BarTender Ultralite program according to PC operating systems(OS).

The followings are supported.

- Windows 10, 8.1, 8, 7 and Vista.
- Windows Server 2016, Server 2012 and 2012 R2, Server 2008 and 2008 R2.
- Includes all 32-bit and 64-bit (x64) editions.

### **8.2 Installation Preparation**

Download BarTender Ultralite application program in CD.

## 8.3 Installation



Note:

- Under different operating systems, the screen may be slightly different. Take Windows 7 as example.
- Take printer iD4P as example. Please refer to printer iD4P when using printer iD4S.
- To avoid the prevention, recommend to close the security software before installation.

1. Double click the application program .

2. Select language, then click "OK".

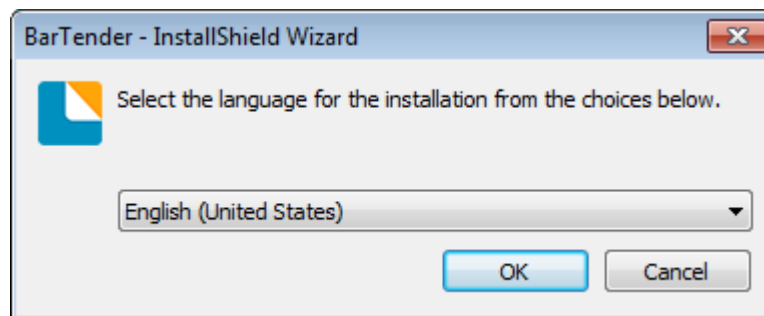

3. Click "Install".

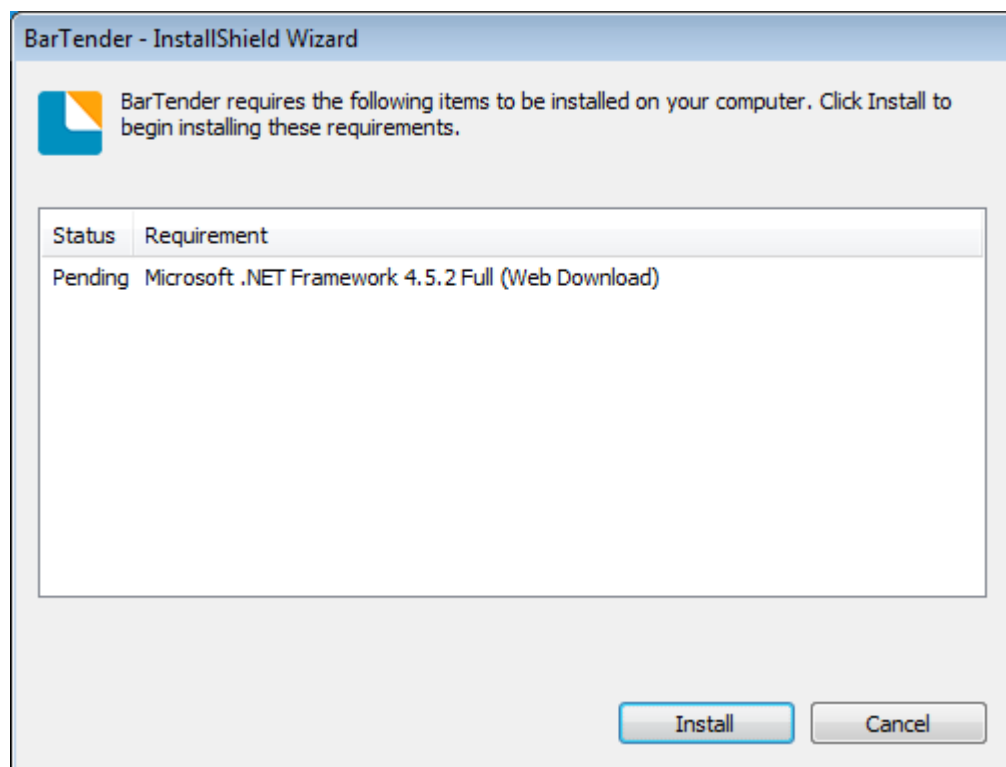

4. Click "Next".

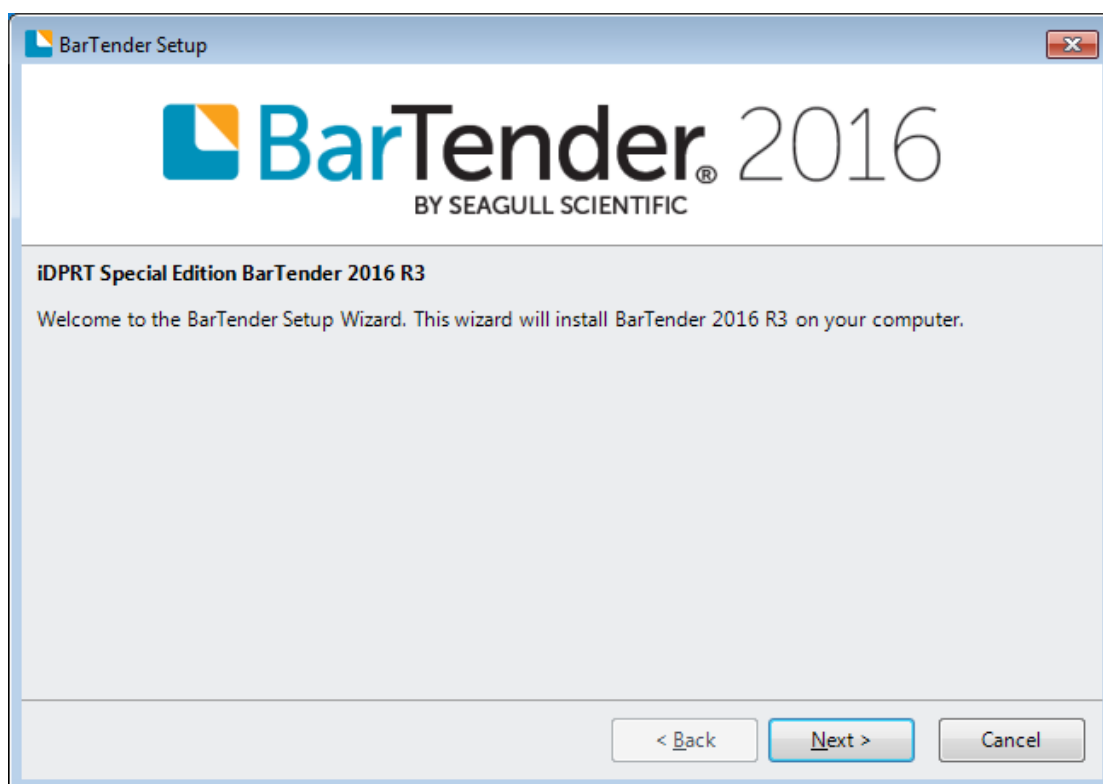

5. Read and accept the license agreement, then click "Next".

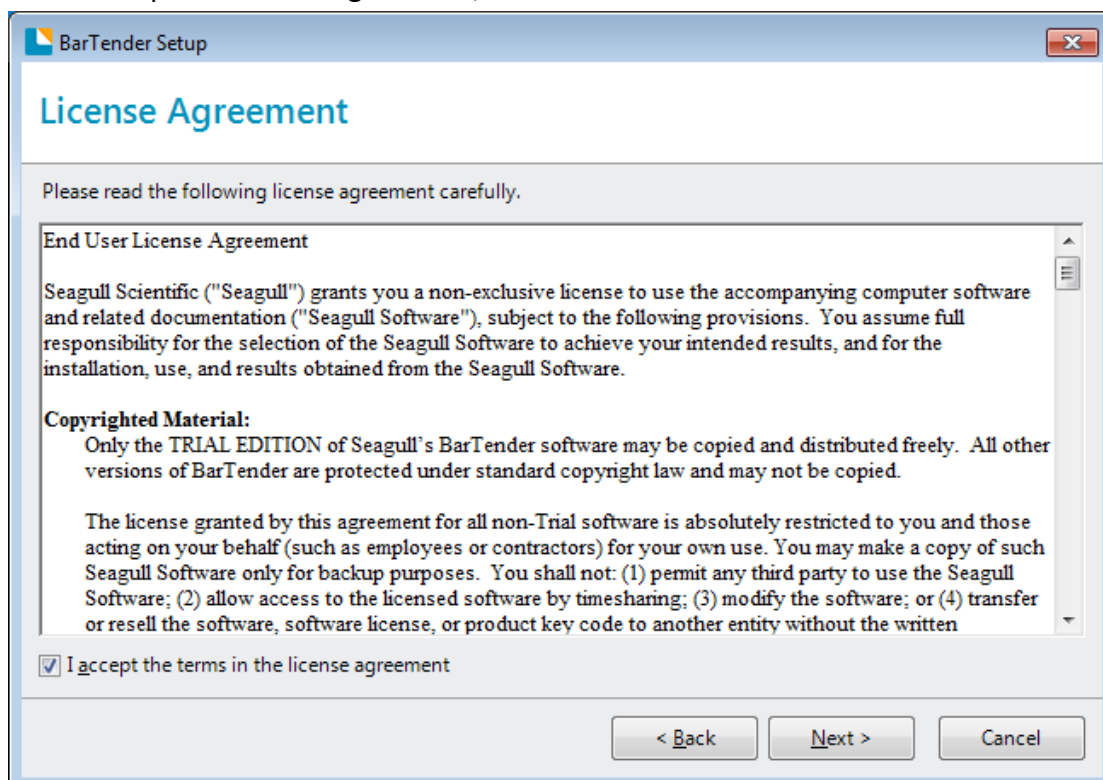

6. Select "Features" and installation location, then click "Next".

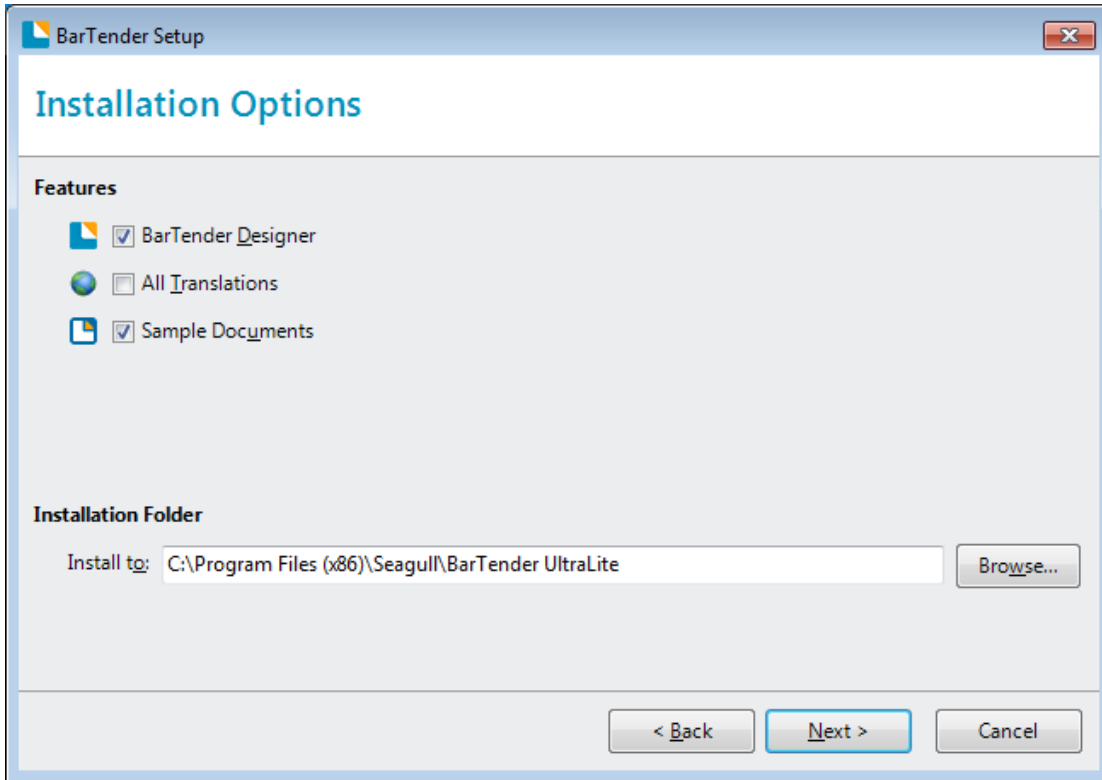

7. Click "Install".

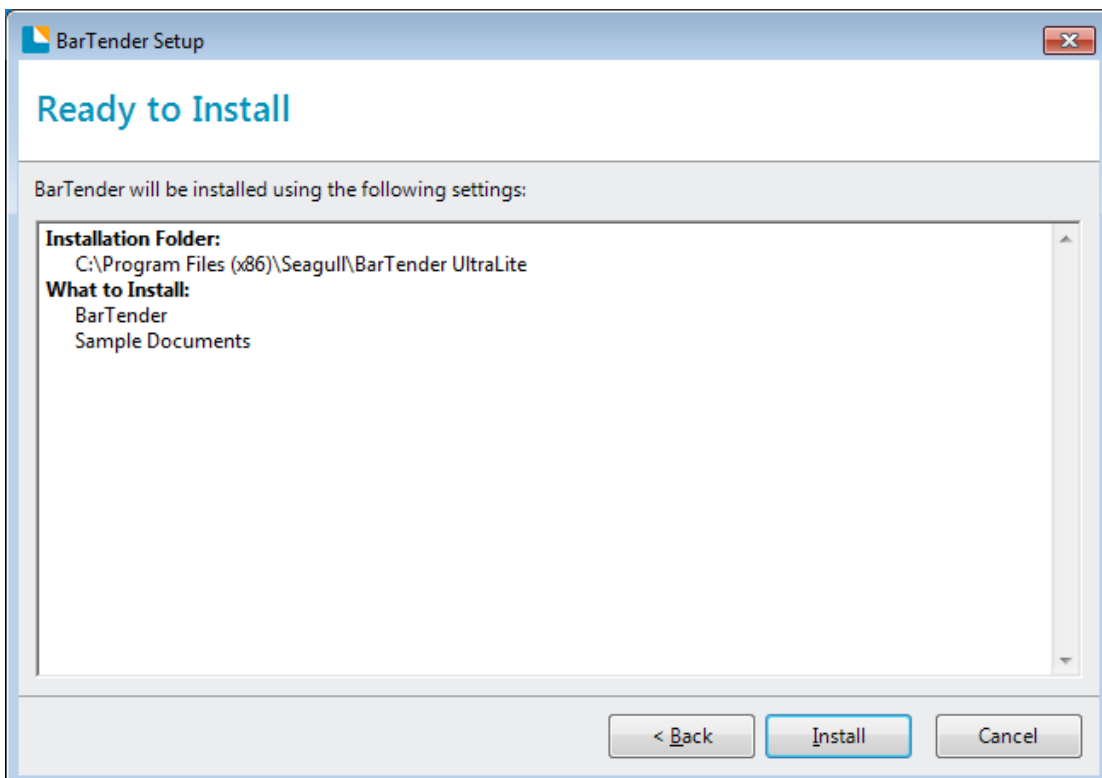

8. Click "Finish".

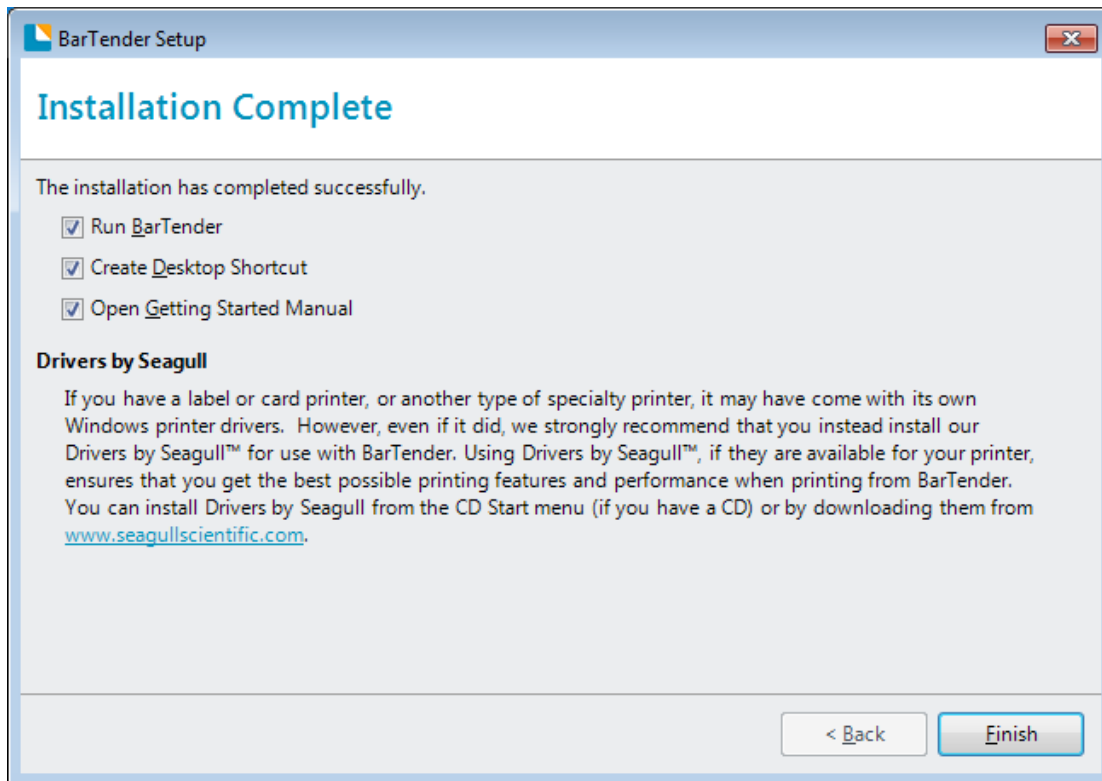

9. Back to desktop, and you will see the icon of BarTender Ultralite. Double click it and get down to use.

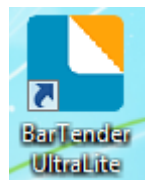

## 8.4 Usage

### 8.4.1 Page Settings

1. Double click the icon, then choose the edition. Click "OK". (The edition may be changed according to different needs.)

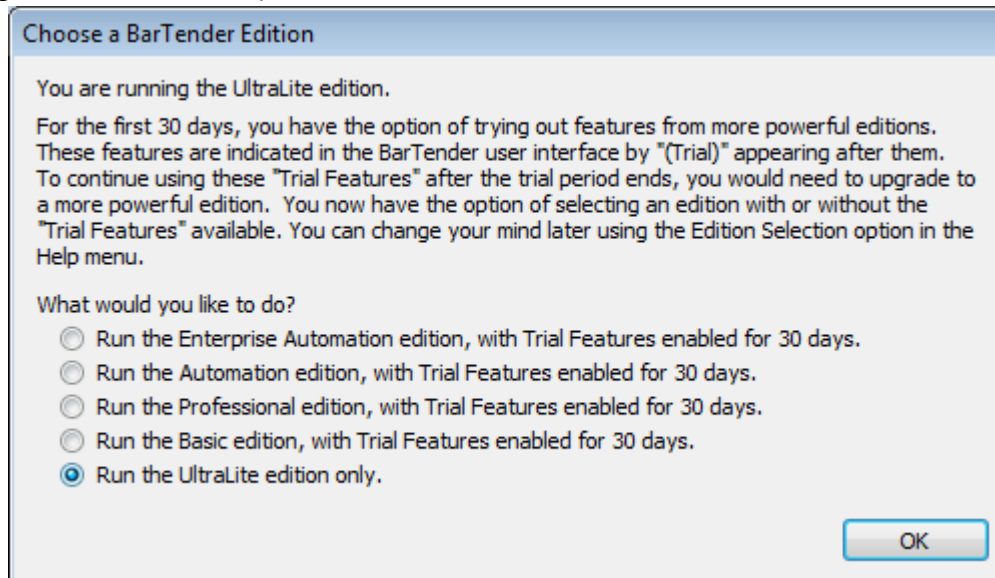

2. Click "Start a new BarTender document".

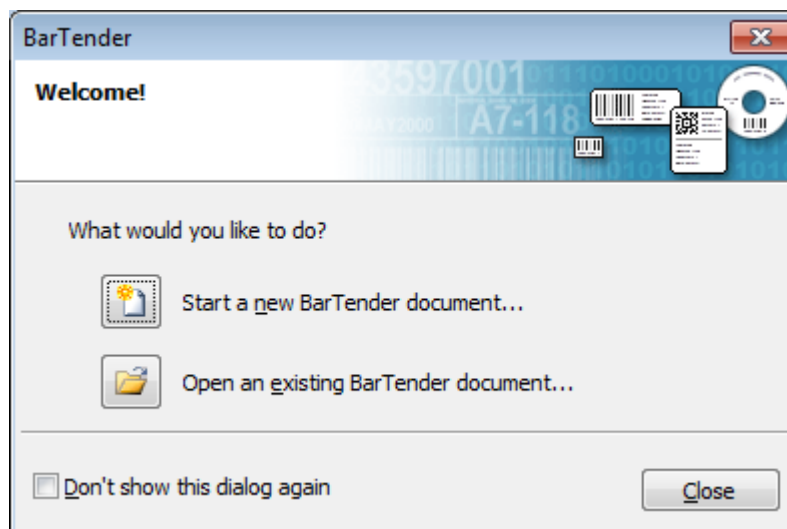

3. Choose “Blank Template”, then click “Next”.

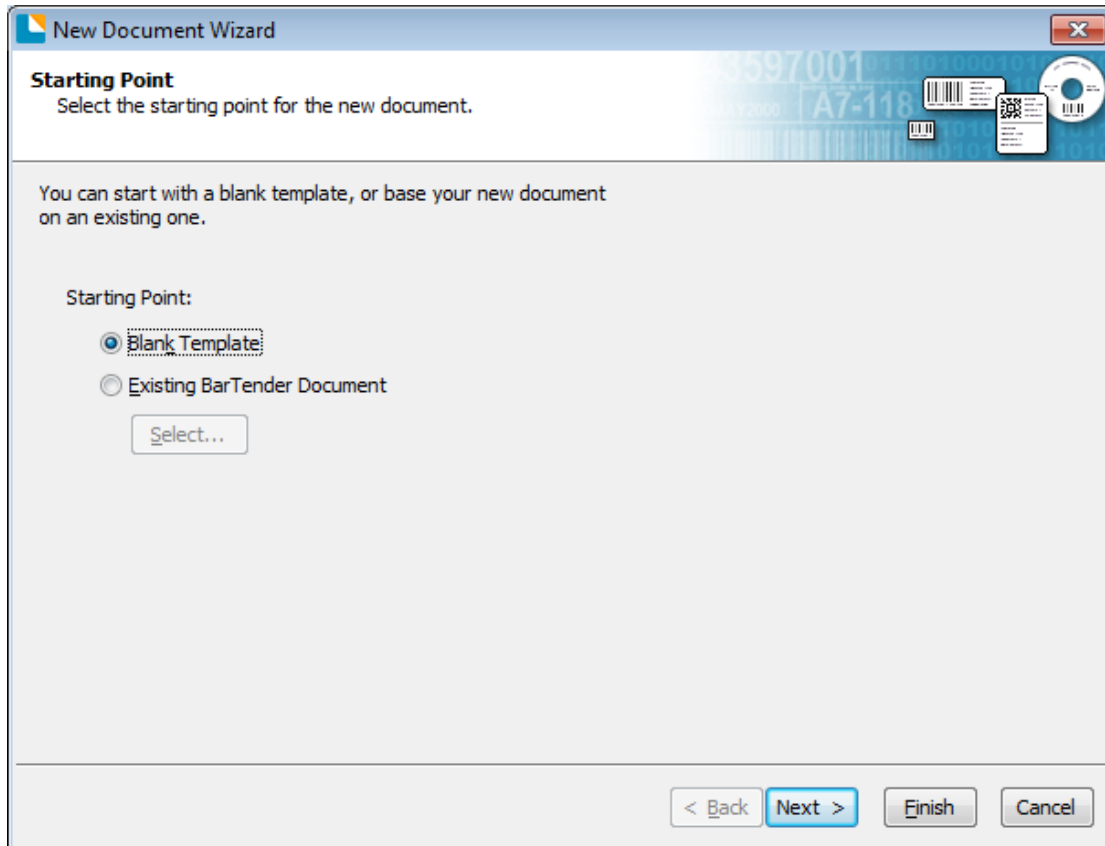

4.If the predefined stocks don't meet your need, tick "Specify Custom Settings". Then click "Next".

The screenshot shows a software window titled "New Document Wizard" with a close button in the top right corner. The main heading is "Stock Selection". Below the heading is a decorative banner with a blue background, featuring a barcode, the number "3597001", and other document-related icons. The main text area contains the following instructions: "A Stock specifies the size of the page, and the size, number, and position of the items on the page. You may select a predefined Stock or specify your own custom settings." Below this text are two radio button options: "Specify Custom Settings" (which is selected) and "Use a Predefined Stock". Under "Use a Predefined Stock", there is a "Category:" dropdown menu and a "Stock Name:" list box. At the bottom of the window, there are four buttons: "< Back", "Next >" (highlighted in blue), "Finish", and "Cancel".

5. Tick “Single item per page”, then click “Next”. (If you print multiple labels, tick “Multiple columns and/or rows of items per page”.)

The screenshot shows a software window titled "New Document Wizard" with a close button in the top right corner. The main heading is "Items Per Page" with the instruction "Specify the characteristics of your media." Below this, a text block explains: "Most media has only a single item (label, card, tag, etc.) per page of stock. Some media, however, are more complex and have multiple items on a page." There are two radio button options: "Single item per page" (which is selected) and "Multiple columns and/or rows of items per page". Under the second option, there are two spin boxes: "Rows:" set to 1 and "Columns:" set to 1. At the bottom right, there are four buttons: "< Back", "Next >", "Finish", and "Cancel". The background of the window features a faint image of various media items like labels, cards, and a CD.

6. Edit the side edges, then click “Next”.

The screenshot shows the 'New Document Wizard' dialog box, specifically the 'Side Edges' step. The title bar reads 'New Document Wizard'. The main heading is 'Side Edges' with the instruction 'Specify the characteristics of the sides of your media.' Below this, a question asks: 'Does your stock have a small amount of unused material between the edge of the item and the edge of the page?'. Two radio buttons are present: the first is selected and labeled 'Yes, it does have some unused material on the sides'; the second is unselected and labeled 'No, it does not'. Underneath, the 'Width of Unused Area:' is specified for both 'Left' and 'Right' sides, each with a text box containing '0.05 in'. To the right, a 'Preview:' window shows a white rectangular area with rounded corners and a double-line border, set against a blue background. Below the preview, it says 'Template Size: 3.998 x 4 in'. At the bottom of the dialog, there are four buttons: '< Back', 'Next >', 'Finish', and 'Cancel'. The 'Next >' button is highlighted in blue. The background of the dialog features a collage of various ID cards and documents.

7. Choose the item shape, then click “Next”.

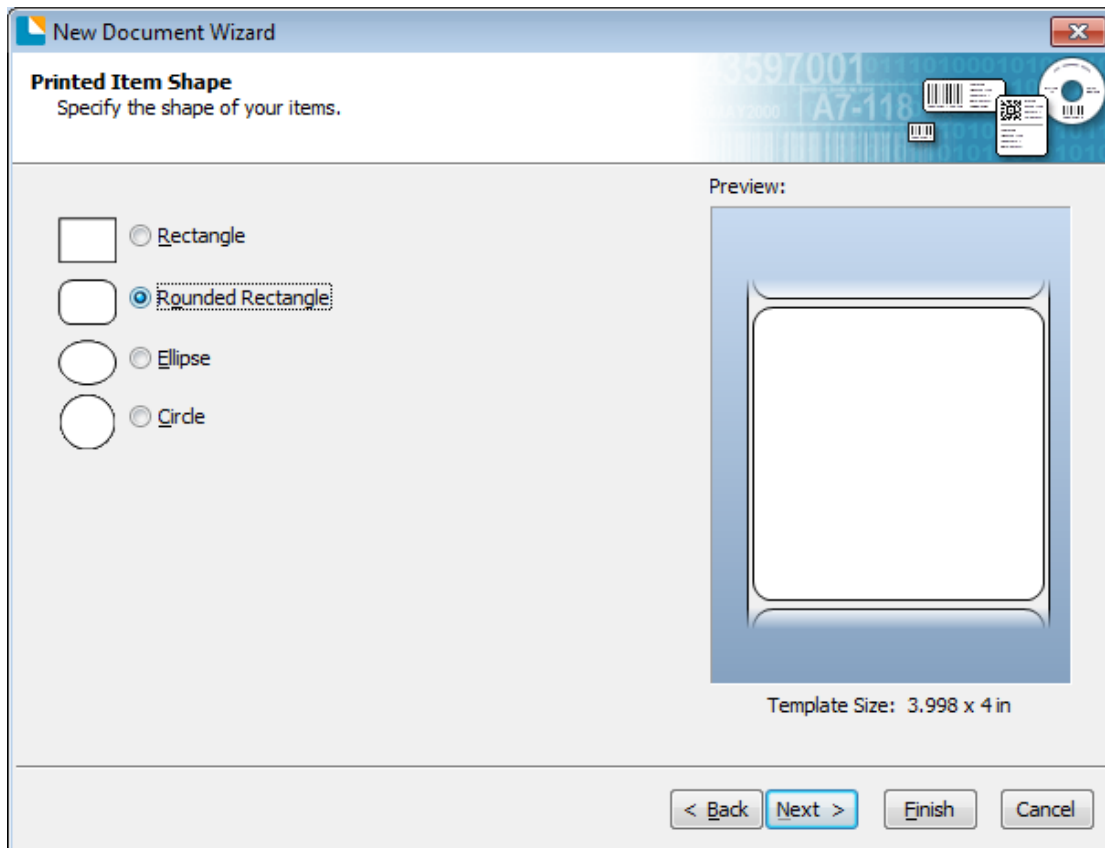

8. Edit the template size, then click “Next”.

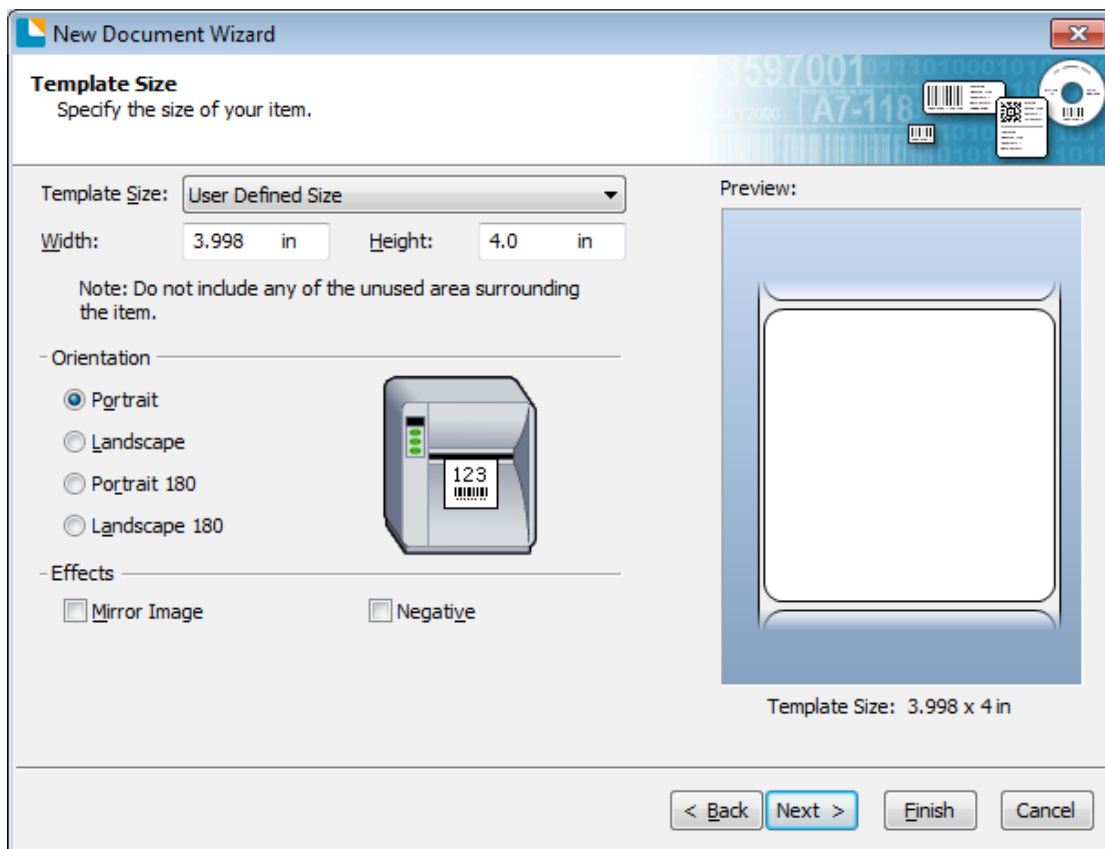

9. Based on your need, edit the template background. Then click “Next”.

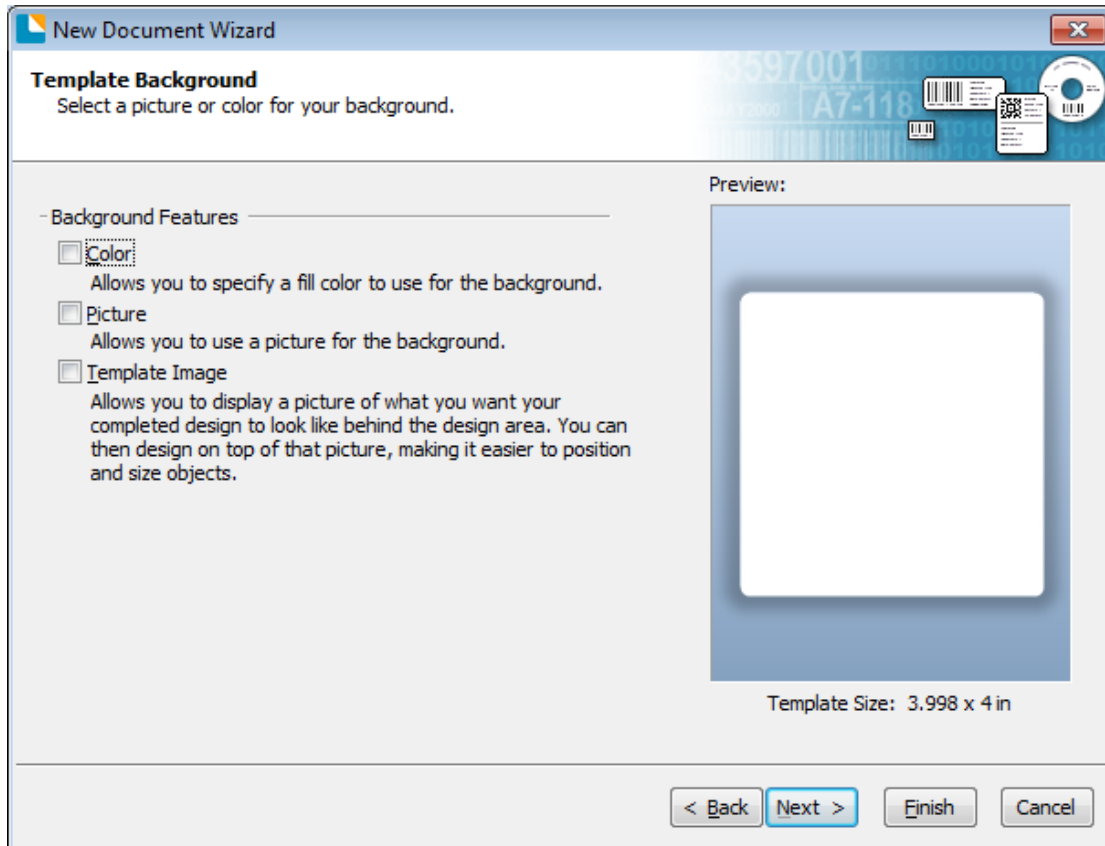

10. Finish the settings, showed in the “Review” and “Preview”. Then click “Finish”.

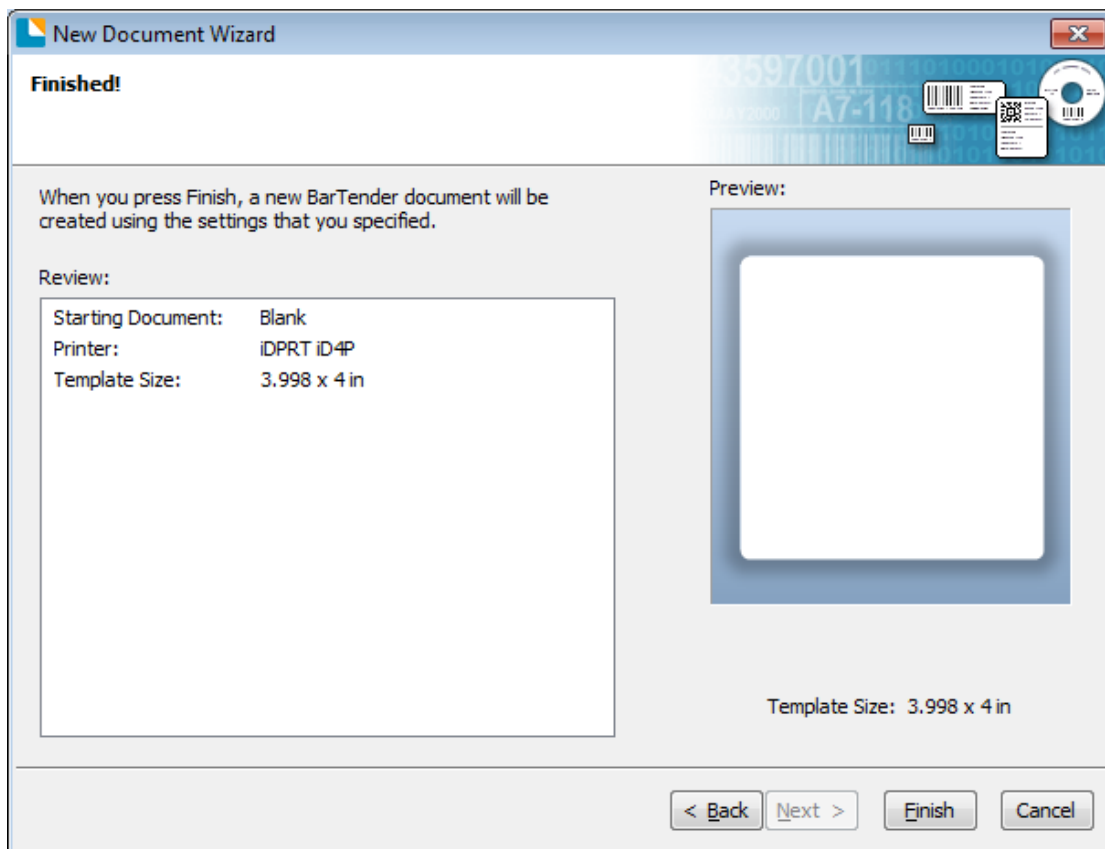

## 8.4.2 label Edit

1. Click the icon of code .
2. Choose the code, then click "Select".

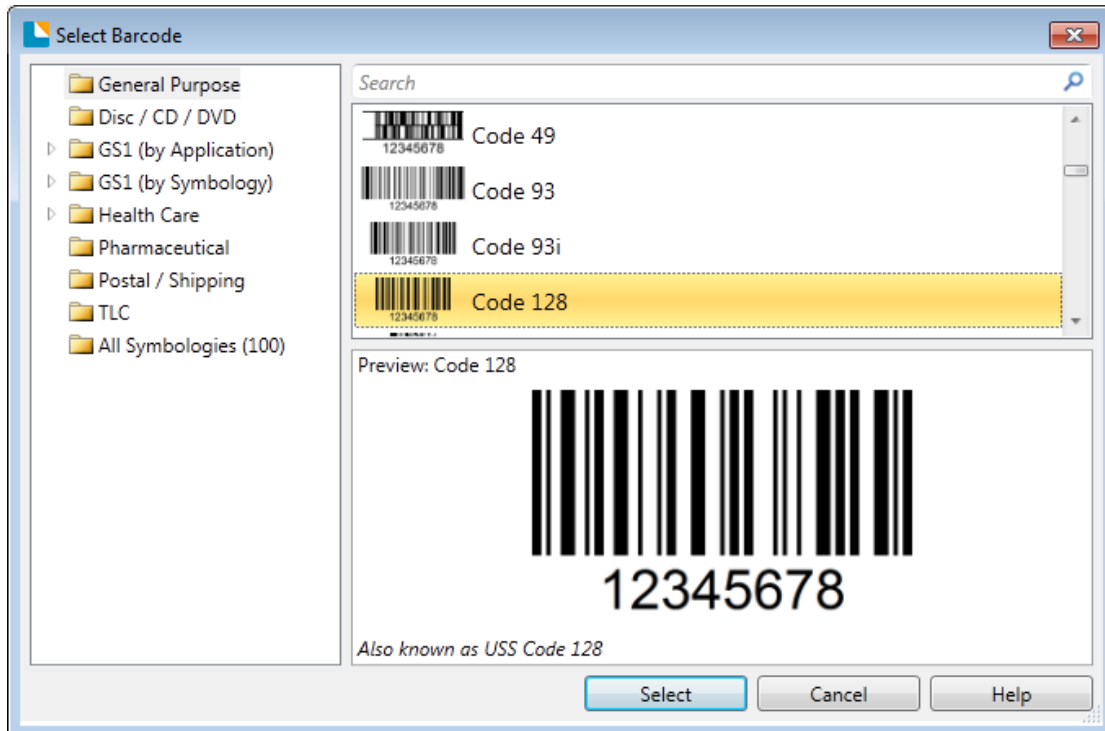

3. Click the blank, showing the code.



4. Double click the code and edit it. User can set up the size, font, border and so on.

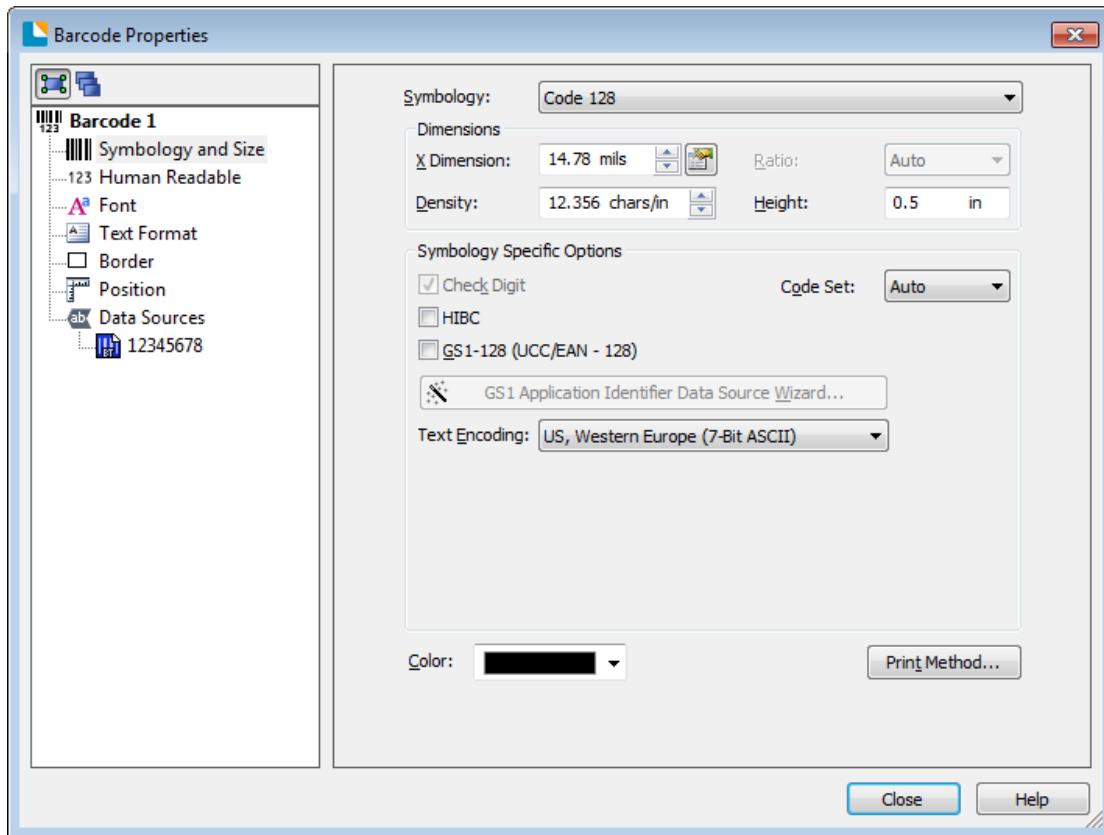

5. Click the icon of character , then enter the text.



6. Click the icon of picture , then edit the pictures.









7. Compose the text.







8. Finish all the settings. Click "Print" and a new label will be printed.

## Appendix 1 Display Operation

Home Menu	Sub-menu	Sub-menu	Value
Setting 	Printer Setup 	Print Method	DT
		Print Speed	2-N ips (varies with different printers)
		Print Darkness	0-N (ZPL/DPL: N=30 EPL: N=20)
		Rotation	0 (Default) 90 180 270
		After Printed	None Tear Off (Default) Peeling Cutting
		Stop Position	Default Manually (0-30mm)
	Label Setup 	Label Type	Gap Label (Default) Black Mark Continuous
		Media Sensor	Auto Sensor (Default) Transmissive Reflective
		PL Simulation	Automatic (Default) ZPL EPL DPL
		Codepage	CP850 (Default) CP852 CP437 CP860 CP863 CP865 CP857 CP861 CP862 CP855

			CP866 CP737 CP851 CP869 Win 1252 Win 1250 Win 1251 Win 1253 Win 1254 Win 1255 Win 1257 UTF-8 UTF-16BE UTF-16LE
		Print Y Offset	+/-120
		Print X Offset	+/-120
		LCD Timeout	0-9
		LCD Brightness	0-9
	LCD Setup 	LCD Language	English (Default) Spanish Portuguese France German Ukrainian 日本語 中文简体 中文繁体
		Security Password	0000 (Default)
		Standby Display	Ready Date/Time
	Int.Device 	Buzzer Volume	0-3 Default: 2
		Date	YYYY/MM/DD
		Time	hh:mm:ss
	RS232 Setup 	Baudrate	9600 (Default) 14400 19200 38400 57600 115200

		Data Bits	7-bit 8-bit (Default)
		Parity	None (Default) Odd Even
		Flow Ctrl	None XON/XOFF Hardware (Default) SW+HW
	<p>Ethernet Setup</p> 	Switch	OFF ON
		Address Mode	DHCP Static (Default)
		Port Number	Default: 9100
		IP Address	Default: 192.168.1.1
		Default Gateway	Default: 255.255.255.0
		Subnet Mask	Default: 192.168.1.0
	<p>Wireless Setup</p> 	Bluetooth Switch	OFF (Default) ON
		SPP Pairing Code	Default: 0000
		WiFi SSID	iD4P (varies with different printers)
		WiFi Switch	OFF (Default) ON
		Networking Mode	AP Mode (Default) Station Mode
	<p>Ext.Device</p> 	Keyboard	None (Default) USB Host RS232

		Keyboard Language	English (Default) Spanish Portuguese France German Ukrainian
		Barcode Scanner	None (Default) USB Host RS232
<p>Testing</p> 	TPH Printed Mileage		Show the mileages printer has printed
	TPH Bad Not Printing Test		Print the testing page
	Label Calibration		Calibrate the label
	Media Sensor Printing		
	Dump Mode		Receive the data
	Cutting Test		Test the cutter
	Restore Factory Default		Enter Cancel (Default)
	Firmware Update Touch Screen Calibration		
<p>Config Info</p> 	Printer Configuration		Print the information of printer's current settings
	Internal Font List		Print all the internal fonts template
	Barcode Lists		Print all the barcodes template
	Internal Flash File List		Print the internal flash file list
	External Memory File List		Print the external flash file list
	LCD Configuration		
<p>Smart Printing</p> 	File Management	Internal Flash(A:)	Label Formats Graphic Bitmap Font True Type Database Firmware

		External USB Storage(B:)	Label Formats Graphic Bitmap Font True Type Database Firmware
	Auto Form	Auto Label Form Switch	OFF (Default) ON
		Delete Auto Label Form	NO (Default) YES

## Appendix 2 Download Path for UTILITY and Driver

1. Enter the website in browser: <http://www.idprt.com>
2. Select the “DOWNLOAD” to get the Utility and Driver.



## FCC-DECLARATION OF CONFORMITY

### Product

We, Xiamen Hanin Electronic Technology Co., Ltd. declare that the product conforms to the following specification: FCC Part 15, Subpart B Class A digital device.

This device complies with Part 15 of the FCC rules. Operation is subject to the following Two Conditions:

- This device may not cause harmful interference;
- This device must accept any interference received, including interference that may cause undesired operation.
- The user is cautioned that any changes or modification not expressly approved in this manual could void the user's authority to operate the equipment. To ensure compliance, this printer must be used with shielded communication cables.
- Use only power supplies listed in this manual and /or recommended and approved in this manual.

## EC DECLARATION OF CONFORMITY

Manufacturer certifies that the following designated product

Type of product

Thermal Transfer label/Direct Thermal Label Printer

It is in conformity with the standards

*Test standard information*

Under the Council Directive: (LVD) Directive 2014/35/EU relating to electrical equipment designed for use within Low Voltage Directive.

EN 60950-1:2006+A11:2009+A1:2010+A12:2011+A2:2013

Under the Council Directive: (EMC) Directive 2014/30/EU relating to Electro Magnetic Compatibility.

EN 55032:2015

EN 55024:2010

EN 61000-3-2:2014

EN 61000-3-3:2013

We declare herewith that as a result of the way in which the device designated below was designed, the type of construction and the devices which, as a result have been brought on to the general market comply with the relevant fundamental regulations of the EC Rules for Safety. And we declare herewith the below mentioned model is conformity with Directive 2014/30/EU and 2014/35/EU. In the event of any alteration which has not been approved by us being made to any device as designated below, this statement shall thereby be made invalid.

The declaration is sole responsibility of the manufacturer

*Name of manufacturer*

Xiamen Hanin Electronic Technology Co., Ltd.



Please refer to the attachment for details of FCC certification.